



A Halma company



OPERATING MANUAL

FOR MASS FLOW CONTROLLERS

Models MC · MCD · MCE · MCQ · MCR · MCS · MCV · MCW

Thank you for purchasing your mass flow controller.

If you have any questions, or if something is not working as expected, please contact us. We are eager to help you in any way possible.

Contact Information

World Headquarters, Tucson, Arizona, USA

info@alicat.com
alicat.com
7641 N Business Park Dr.,
Tucson, AZ 85743 USA
+1 888-290-6060

China & SE Asia

info-cn@alicat.com
alicat.com.cn
2nd Floor, Block 63, No. 421,
Hong Cao Rd,
Shanghai 200233
PRC
+86-21-60407398 ext. 801

Europe

europa@alicat.com
Geograaf 24
6921 EW Duiven
The Netherlands
+31 (0)26 203.1651

India

india@alicat.com
Halma India Pvt. Ltd.
Plot No . A-147, Road No. 24,
Next to Spraytech Circle
opp. Metropolitan Company,
Wagle Industrial Estate
Thane-West
Mahārāshtra 400 604
+91 022-41248010

Recalibrate your mass flow controller every year.

Annual calibration is necessary to ensure the continued accuracy of readings, and to extend the Limited Lifetime Warranty. Fill out the Service Request Form at alicat.com/service, or contact us directly when it is time to send in your device for recalibration.

For devices ordered with CSA, ATEX, ISO 17025, or other certifications, please visit alicat.com/certifications. For information about our limited lifetime warranty, visit alicat.com/warranty.

Serial #: _____

Next Calibration: _____



This device comes with a NIST-traceable calibration certificate.



This device conforms to the European Union's Restriction of Use of Hazardous Substances in Electrical and Electronic Equipment (RoHS) Directive 2011/65/EU.



This device complies with the requirements of the Low Voltage Directive 2014/35/EU and the EMC Directive 2014/30/EU and carries the CE Marking accordingly.



This device complies with the requirements of the European Union's Waste Electrical & Electronic Equipment (WEEE) Directive 2002/96/EC

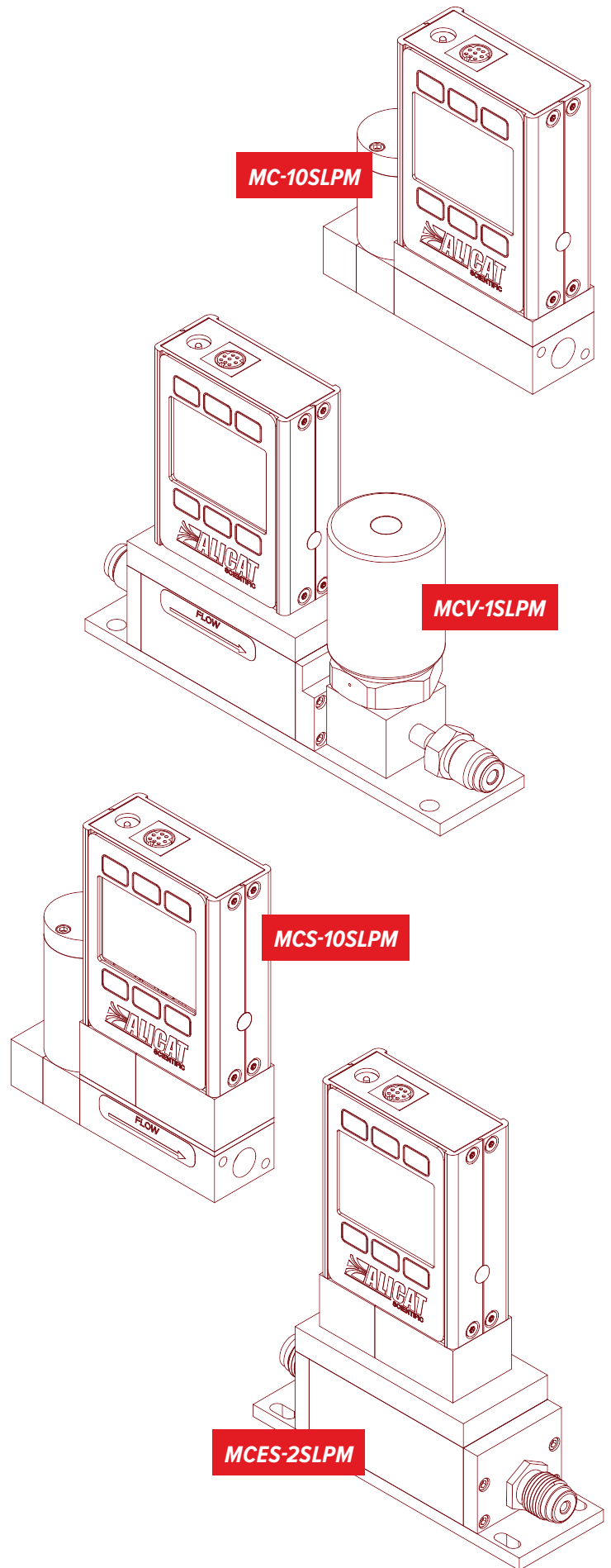

Introduction

Your new flow controller has a variety of innovative features:

- **High-accuracy performance for all your gases.** Use your flow controller with any of the 98+ gases included with Gas Select™, [page 18](#).
- **Control pressure while monitoring flow rate.** Set the closed loop control algorithm to pressure control, [page 15](#).
- **1000 readings per second** guarantees high resolution data, [page 21](#).
- **Monitor live pressure and temperature** during flow control, [page 10](#).
- **Backlit display with adjustable contrast** is easy to read even in direct sunlight. In dimly lit areas, press the logo to turn on the backlight, [page 21](#).
- **Change your STP** to match any standard temperature and pressure reference, [page 20](#).
- **Log data to your PC** with a serial data connection to control the device and capture data for logging and analysis, [page 23](#).

This manual covers the following instruments:

- **MC-Series:** gas mass flow controllers
- **MCW-Series:** low pressure drop gas mass flow controllers
- **MCS-Series:** anti-corrosive gas mass flow controllers
- **MCQ-Series:** high-pressure gas mass flow controllers
- **MCE-Series:** SEMI compatible gas mass flow controllers
- **MCV-Series:** vacuum gas mass flow controllers
- **MCD-Series:** dual-valve gas mass flow controllers

For support or questions regarding the use or operation of this device, please contact us using the information on page 2.

Alicat offers countless combinations of device sizes, accessories, connections, and configurations. These custom solutions are offered to meet a variety of application challenges brought forth by users pushing the boundaries of our standard offerings.

If you have an idea for a new process or a challenging application, contact Alicat for specialized engineering and application support.

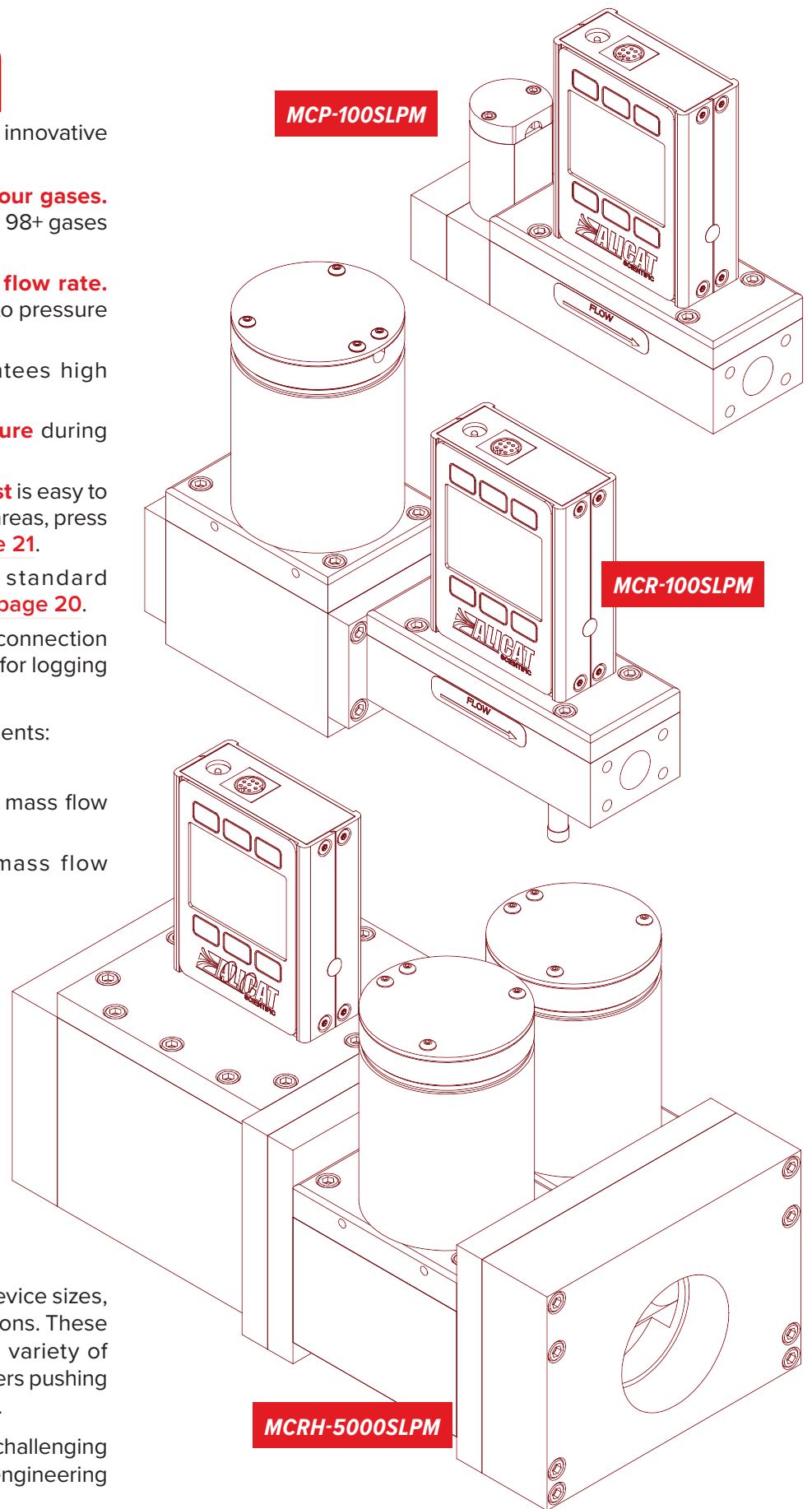

Contents

Introduction	3	Setup	18
Quick Start Guide	5	Gas Selection	18
Getting Started	6	Gas Select™.....	18
Getting to Know Your Mass Flow Controller	6	Using COMPOSER™ Gas Mixes.....	18
The Flow Controller Display.....	6	Creating New Mixes in COMPOSER™.....	19
Status Messages.....	6	Viewing, Deleting, and Creating Similar Mixes.....	19
Mounting	6	Sensor Setup	20
Filters	6	Choosing Engineering Units.....	20
Device Ports	7	Defining STP/NTP Reference Values.....	20
Connecting Your Gas Flow Controller	7	Flow and Pressure Averaging.....	20
MCV Controller Operating Notes	8	Zero Band.....	20
MCD Dual Valve Controller Operating Notes	8	Configuring Serial Communications	21
Power and Signal Connections	9	Unit ID.....	21
Analog Signals.....	9	Modbus RTU Configuration.....	21
Displaying Live Data	10	Baud Rate.....	21
Option: Color TFT Display	11	Display Setup	22
Option: Collecting Totalized Flow Data	11	Main Screen Options.....	22
Dispensing Gas in Batches.....	12	Screen Lighting.....	22
Repeating a batch.....	12	Display Rotation.....	22
Pausing or canceling a batch.....	12	Advanced Setup	22
Control	13	Serial Communication	23
Changing the Setpoint	13	Modbus RTU Communication	23
Adjusting Setpoint with an IPC.....	13	Establishing Communication	23
Setpoint Setup	13	Polling Mode.....	23
Using Autotare.....	13	Streaming Mode.....	24
Changing Between Setpoint Sources.....	13	Taring	24
Managing Setpoint with an Idle Modbus Connection.....	13	Collecting Data	24
Managing Setpoint on Power-Up.....	13	Commanding a New Setpoint	25
Establishing Setpoint Limits.....	14	Sending Setpoints as Floating Point Numbers.....	25
Control Loop	14	Using Gas Select™ and COMPOSER™	25
Changing the Controlled Variable.....	14	Quick Command Guide	26
Adjusting the PD/PDF or PD ² I Control Algorithms.....	14	Troubleshooting	27
Tuning the PD ² I Control Algorithm.....	15	General Use	27
Troubleshooting Valve Performance with PID Tuning.....	15	Flow Readings	27
Limiting Flow Rate While Controlling Pressure.....	15	Serial Communications	28
Using a Control Deadband for Pressure Control.....	16	Maintenance	28
Setpoint Ramping	16	Cleaning	28
Setting the Ramp Rate.....	16	Recalibration	28
Ramping Options.....	16	Reference Information	29
Displaying Valve Drive Percentage	17	Engineering Units	29
Device Information	17	Gas List by Number	30
		Gas List by Category	31
		Pinouts	32
		8-Pin Mini-DIN (Default).....	32
		Locking Industrial Connector Pinout.....	32
		9-Pin D-Sub Connector Common Pinouts.....	33
		15-Pin D-Sub Connector Common Pinouts.....	33
		M12 Connector Common Pinouts.....	34

Quick Start Guide

Setup

- **Connect your flow controller.** Ensure that flow will pass through your device in the same direction as the arrow on the flow body (usually left to right).
- **Choose your engineering units.** You can choose the measurement units by selecting **MAIN MENU** → **SETUP** → **Sensor** → **Engineering Units**, see [page 20](#) for more details.

This MC-1SLPM-D model mass flow controller is a typical unit. The flow body and the valve sizes can vary significantly.

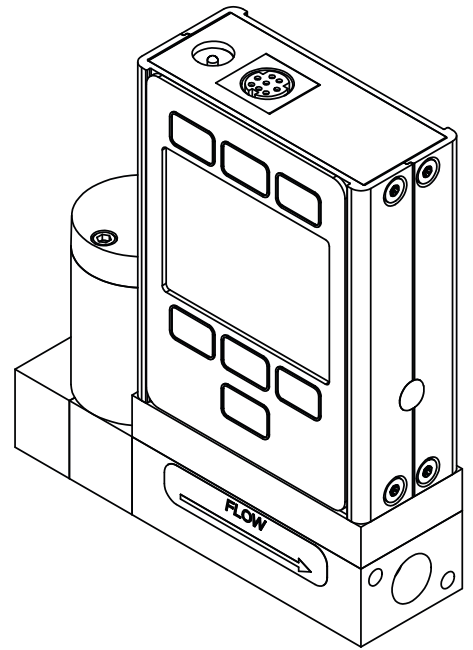

Operation: Flow Verification

- **Monitor live flow, temperature, and pressure readings.** Readings are updated and displayed on your device in real time. See [page 6](#).
- (Optional) **Capture totalized readings.** The totalizer option displays the total flow that has passed through the device since the last time the totalizer was reset. If your device has a totalizer, press **NEXT** from the main live data display to access the totalizer. See [page 11](#).

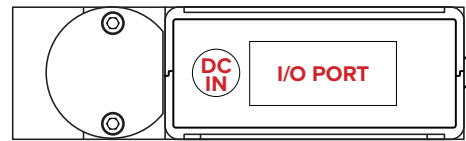

Connectors and Buttons

The drawing to the right represents a typical configuration of a standard mass flow controller. **Your flow controller's appearance and connections may differ.** See [page 2](#) for more examples.

Backlight

The monochrome display comes equipped with a backlight. **To toggle the backlight power, press the logo on the front of your device.**

For optional color TFT displays, pressing this button will turn off the display to conserve power. See [page 11](#).

Maintenance and Care

- Flow controllers do not require cleaning when flowing clean, dry gases. Read more on [page 28](#).
- Calibrate your flow controller annually. To schedule a calibration, please contact support ([page 2](#)).

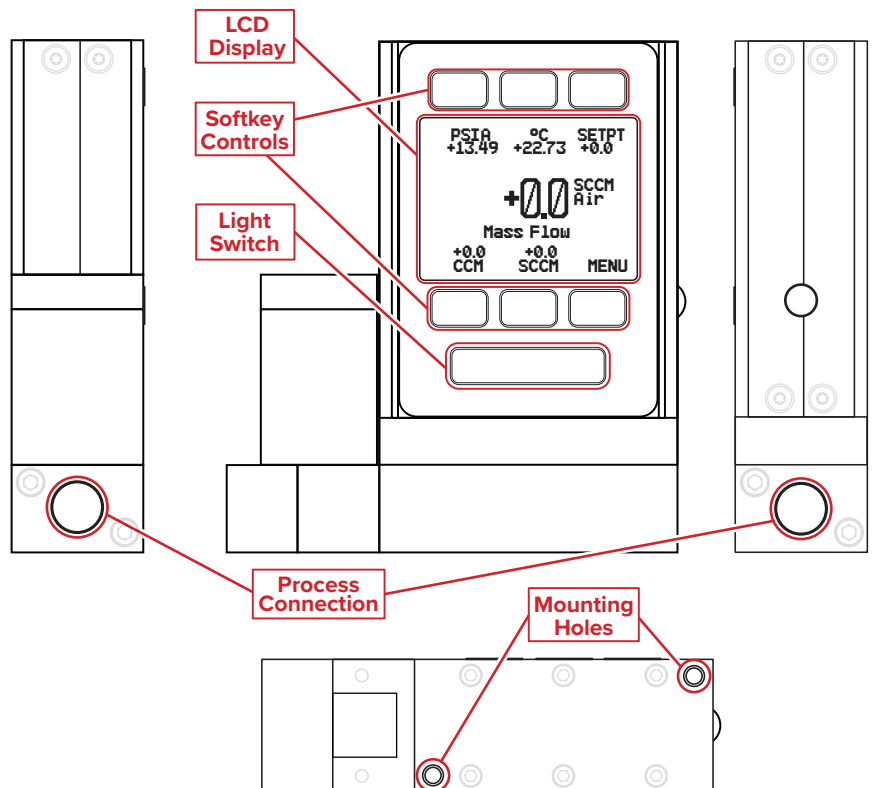

Getting Started

Getting to Know Your Mass Flow Controller

The Flow Controller Display

The figure to the right identifies the various features of the flow controller display.

- 1 Highlights **pressure** in the center of the device.
- 2 Highlights **temperature** in the center of the device
- 3 Opens a menu to set the **flow or pressure control setpoint** (page 13).
- 4 Highlights **volumetric (actual) flow** rate in the center of the device.
- 5 Highlights **mass flow** rate in the center of the device (default).
- 6 **MENU** enters the **main menu** system.
NEXT accesses the optional **flow totalizer** (page 11).
- 7 Toggles the backlight.

Status Messages

Status messages are shown to the right of the main readout number. In the example to the right the **OVR** message indicates that the totalizer rolled over to zero.

ADC Analog-digital converter error	OVR Totalizer rolled over to zero
EXH Exhaust mode active	POV Pressure over range of device
HLD Valve hold active	TMF Totalizer missed out-of-range flow
LCK Front display is locked	TOV Temperature over range of device
MOV Mass flow over range of device	VOV Volumetric flow over range of device

Mounting

Flow controllers do not require straight runs of pipe upstream or downstream. Most flow controller models can be mounted in any position, including upside-down. Corrosive-resistant flow controllers use media-isolated sensors that must be tared after changing orientation.



Caution: Flow controllers with large Rolamite valves (see example to the right) should be mounted with their valve oriented vertically (right-side up). For other orientations, please contact support.

Filters

When pressure drop is not a concern, use in-line sintered filters to prevent large particulates from entering the flow body of the controller. Suggested maximum particulate sizes are as follows:

- **5 microns** for units with flow ranges ≤ 1 SCCM.
- **20 microns** for units with flow ranges between 1 SCCM and 1 SLPM.
- **50 microns** for units with flow ranges ≥ 1 SLPM.

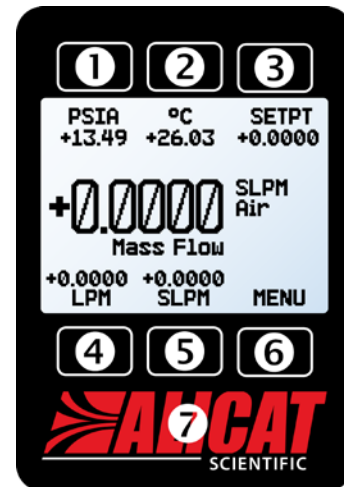

The **Main Display**. Note the button behind the logo, which toggles the device backlight.

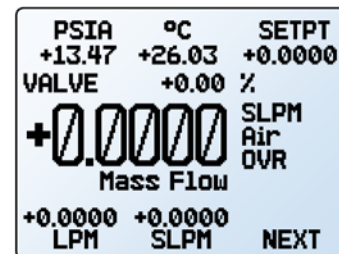

The **Main Display** with barometer (PSIG), valve % displayed (page 17), an **OVR** status message, and a totalizer (the **NEXT** button).



An **MCR-50SLPM-TFT** mass flow controller, with its attached large Rolamite valve.

Device Ports

Your controller has been shipped with plastic plugs fitted into its ports. To decrease the chance of contaminating the flow stream, do not remove these plugs until you are ready to install the device.

Standard gas flow controllers have female inlet and outlet ports. VCR®-compatible and other specialty fittings may have male connections.

- If you are using a fitting that does not have a face seal, use thread-sealing Teflon tape to prevent leakage around the port threads, but do not wrap the first two threads entering the device. This will minimize the possibility of getting tape into the flow stream and clogging the laminar flow elements.
- Face seal fittings do not need Teflon tape applied to the threads.

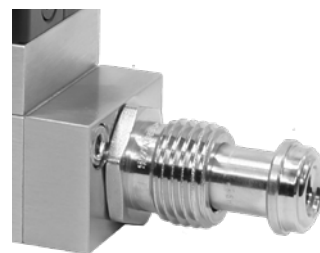

A mass flow controller with male VCR®-compatible connections.

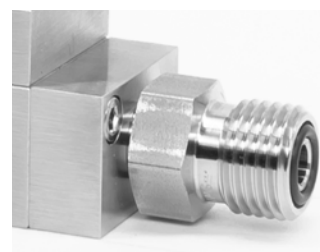

A mass flow controller with male VCO®-compatible connections.

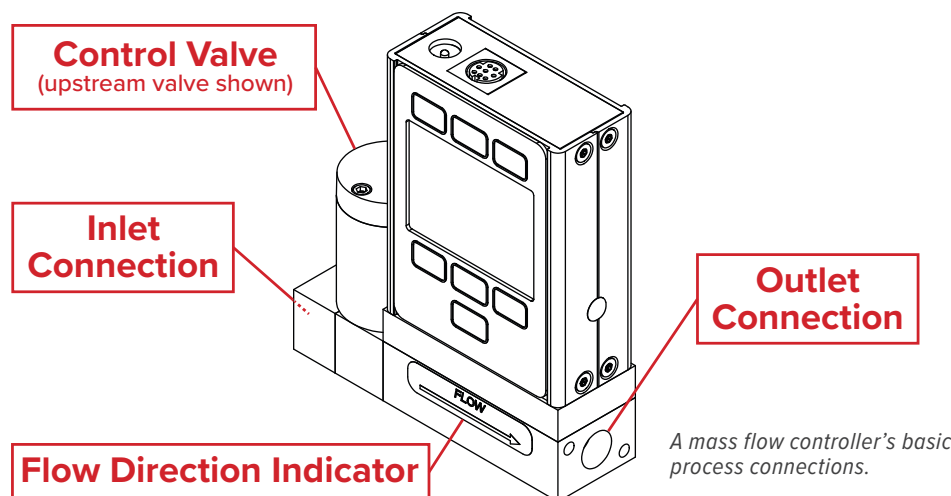

A mass flow controller's basic process connections.



Warning: It is not recommended to use pipe dopes or sealants on the process connections as these compounds can cause permanent damage to the controller should they get into the flow stream.

Connecting Your Gas Flow Controller

Your flow controller can measure and control flow generated by positive pressure and/or suction. Connect the controller so that the flow travels in the same direction as the flow arrow, usually from left to right from the front of the device.



Warning: Using the flow controller above the maximum specified common mode, or changing the pressure by more than the maximum recommended differential pressure too quickly, will result in permanent damage to the internal pressure sensors.

Model	Maximum Common Mode Pressure	Maximum Differential Pressure*
Standard controllers	175 PSIA	75 PSID
Low-pressure-drop controllers	80 PSIA	10 PSID
High-pressure controllers	400 PSIA	75 PSID

* The maximum differential pressure only applies to the measurement portion of the device, and the valve will act as a buffer. The most common cause of this problem is giving the device a non-zero setpoint prior to applying the pressure or suction to create flow. This will cause the valve to be fully open and expose the sensor to any instantaneous changes in pressure, such as from a snap-acting solenoid valve.

MCV Controller Operating Notes

Alicat's MCV mass flow controller is equipped with an integrated Swagelok® positive shutoff valve. This valve is normally closed, but can be opened by supplying 60–120 PSIG of air pressure. The shut-off valve closes again when this pressure is reduced below 60 PSIG.

A common method for actuating the shutoff valve incorporates a three-way solenoid valve (shown to the right). Pressure is applied to one side of the solenoid valve while the other side of the solenoid is left open to atmosphere. When the solenoid is energized, pressure is delivered to the shutoff valve, causing it to open. When the solenoid is returned to a relaxed state, the gas vents to atmosphere, allowing the shut-off valve to close.



An MCV-1SLPM-D mass flow controller.

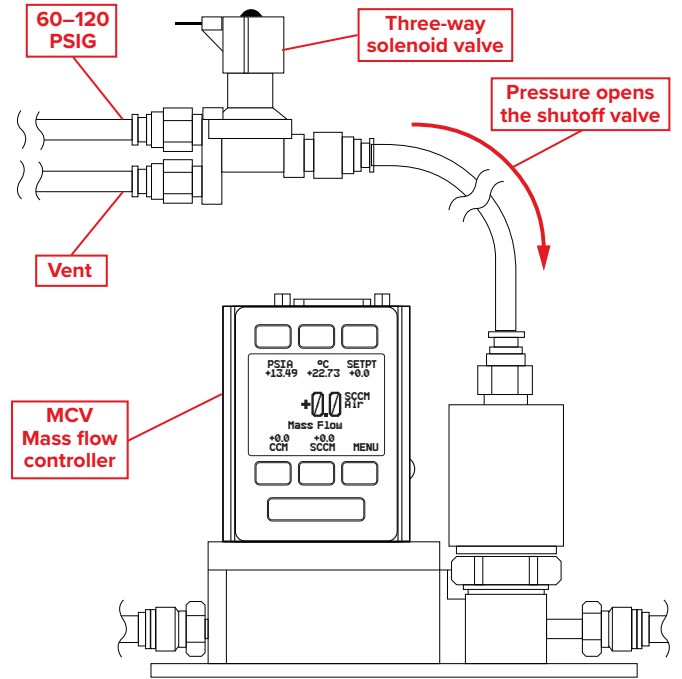

A typical MCV configuration.

MCD Dual Valve Controller Operating Notes

The MCD is a versatile dual-valve mass flow controller that can be used to:

- Measure mass flow and volumetric flow in both directions, plus absolute pressure and temperature.
- Control mass or volumetric flow from a pressurized source or to vacuum.
- Control pressure in a flowing process.
- Control pressure in a closed volume with automatic venting.



An MCD-1SLPM-D mass flow controller.

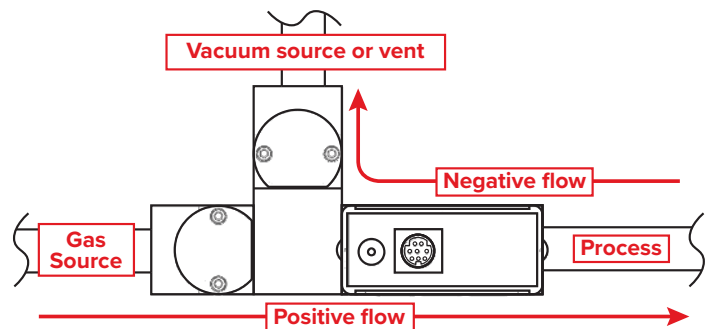
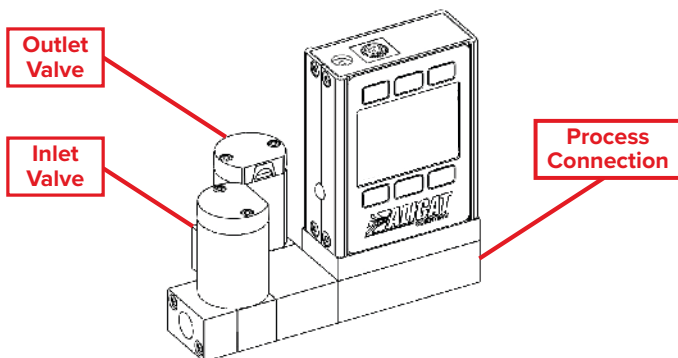

Power and Signal Connections

Power can be supplied to your controller through either the power jack or the multi-pin connector on top of your device.



Note: Power requirements vary based on analog configuration and valve type. Please reference the associated specification sheet at alicat.com/specs for power requirements.

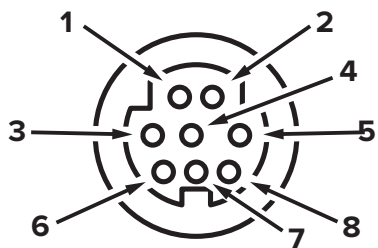

Female Connector: Device

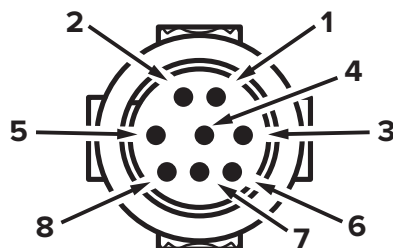

Male Connector: Cable



MC-50SCCM-D mass flow controller with the 8-pin Mini-DIN connector on top.

Standard 8-Pin Mini-DIN Pinout

Pin	Function
1	Not Connected <i>Optional: 4–20 mA primary output signal</i>
2	Static 5.12 Vdc by default. <i>Optional: secondary analog output (4–20 mA, 0–5 Vdc, 1–5 Vdc, 0–10 Vdc) or basic alarm</i>
3	Serial RS-232 RX / RS-485(-) Input Signal (receive)
4	Analog Setpoint Input
5	Serial RS-232 TX / RS-485(+) Output Signal (send)
6	0–5 Vdc <i>Optional: 1–5 Vdc or 0–10 Vdc output signal</i>
7	Power In (as described above)
8	Ground (common for power, digital communications, analog signals and alarms)

The above pinout is applicable to all devices with the Mini-DIN connector. The availability of different output signals depends on the options ordered. Optional configurations are noted on the unit's calibration sheet.



Caution: Do not connect power to pins 1 through 6, as permanent damage can occur. It is common to mistake pin 2 (labeled 5.12 Vdc Output) as the standard 0–5 Vdc analog output signal. Pin 2 is normally a constant 5.12 Vdc.

For more pinout configurations, see [page 32](#) to [page 34](#).

Analog Signals

Primary Analog Output Signal

Most devices include a primary analog output signal, which is linear over its entire range. For ranges that start at 0 Vdc, a zero-pressure condition is indicated at approximately 0.010 Vdc. Full scale pressure is indicated by the top of the range: 5 Vdc for 0–5 Vdc, 20 mA for 4–20 mA signals, and so on.

Option: Secondary Analog Output Signal

The default 8-pin Mini-DIN connector places the secondary analog output on pin 2 for both voltage and current signals. Your device's secondary analog signal may differ from its primary output signal.

The calibration sheet that shipped with the device shows which output signals were ordered.

Option: 4–20 mA Current Output Signal

If your controller has a primary or secondary 4–20 mA current output signal, your flow controller will require 15–30 Vdc power.



Caution: Do not connect 4–20 mA devices to “loop powered” systems, as this will damage portions of the circuitry beyond repair and void the warranty. If you must interface with existing loop powered systems, always use a signal isolator and a separate power supply.

Displaying Live Data

Main Display

The **main display** has three primary functions:

- Displaying live temperature, pressure, and flow data
- Changing the flow or pressure control setpoint ([page 13](#))
- Accessing the **main menu** (MENU) or the optional totalizer (NEXT) ([page 11](#))

This screen displays live data for all flow parameters simultaneously. Live data is measured 1000 times per second and the LCD display is updated 10 times per second. The button next to the four measurements highlight their values in the center.

Taring Your Flow Controller

MENU → TARE FLOW or TARES

Taring is an important practice that ensures your flow controller provides its most accurate measurements. This function gives the flow controller a zero reference for flow measurements. For controllers with a barometer, the absolute pressure reading can also be tared when the device is exposed to the local barometric pressure.

How to Tare

When auto tare is on (**Autotare: On**), flow rate is tared whenever a zero setpoint is given for more than two seconds. See ([page 13](#)).

Taring Flow

MENU → TARES → TARE FLOW

Flow tares should take place at the expected process pressure, with no flow. A message, "ENSURE NO FLOW BEFORE PRESSING TARE" will be displayed. Press TARE to complete the taring process.

Optional: Taring Pressure

MENU → TARES → TARE PRESS

Absolute pressure tares require an optional barometer, and the controller open to atmosphere. A message, "PRESS TARE WHEN VENTED TO AMBIENT WITH NO FLOW" followed by "CURRENT PRESSURE OFFSET:" will be displayed. The offset between the absolute pressure sensor in the flow body and the internal barometer will also be displayed.

When to Tare

- Before every new flow measurement cycle
- After significant changes in temperature or pressure
- After dropping or bumping the flow controller
- After changing the device's orientation

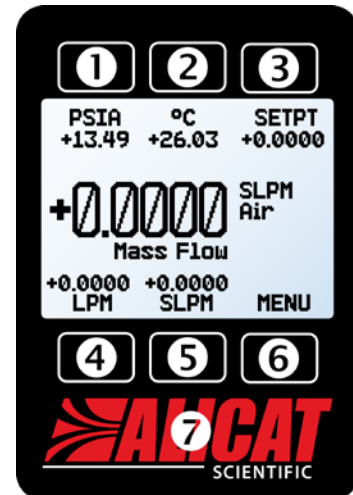

The main display.

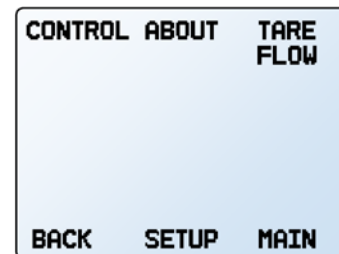

Tare mass flow by selecting TARE FLOW from the main menu (top), or TARES if the device has a barometer (above).

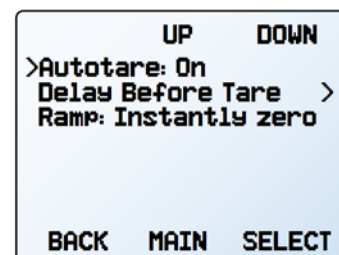

The zero setpoint (autotare) menu with autotare on (see [page 13](#)).

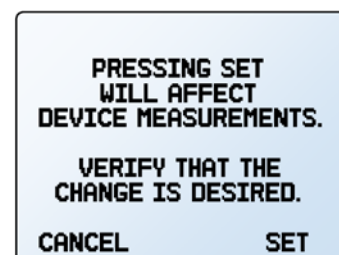

The tare confirmation screen.

Option: Color TFT Display

Instruments ordered with a color display are functionally the same as standard backlit monochrome instruments. The color enables additional on-screen information.

Multi-Color Display Indicators

- **GREEN:** Parameter labels and adjustments associated with the button directly above or below the label are presented in green.
- **WHITE:** The color of each parameter will be displayed in white when the device is operating within device specifications.
- **RED:** The color of a parameter will be displayed in red when its value exceeds 128% of the device's specifications.
- **YELLOW:** Menu items that are ready to be selected appear in yellow. This color replaces the > symbol in selections on monochrome display.



A typical TFT display.



Note: Press the logo to turn off the color display backlight. The flow controller remains in operation while the backlight is off.



Note: Color displays will require an additional 40 mA when using a 12 Vdc power supply. All other device specifications from your device's specification sheet remain in effect.

Option: Collecting Totalized Flow Data

MAIN DISPLAY → NEXT (totalizer menu)

The optional flow totalizer displays the total amount of mass or volume that has flowed through the instrument since its last reset, similar to a gasoline pump. It also enables batch dispensing ([page 12](#)).

- **TOTAL/TIMER** toggles between totalized flow and elapsed time as the highlighted parameter in the center.
- **SETPT** displays the current setpoint. Press to set or clear a setpoint ([page 13](#)).
- **SLPM** (or another measurement of mass flow) displays the live flow rate. Press to change engineering units.
- **(Optional) M AVG** or **V AVG**: Shows totalizer averaging, which displays average flow rate since last reset, updated live.
- **SL** (in this example): Alternating display of selected engineering units for flow or time ([page 20](#)) and the selected gas ([page 18](#)).
- **BATCH** selects the quantity to be dispensed in each batch. **-NONE-** appears if the batch mode is off.
- **RESET** clears all totalized data and immediately resets the timer to 0. The next batch, if set, begins immediately.
- **MENU** enters the main menu.

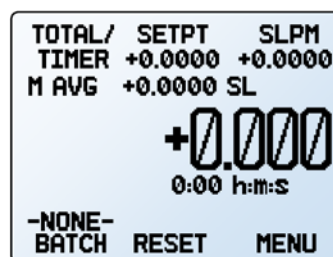

The totalizer displaying a mass flow average without a batch.

Totalizer Rollover Functions

The totalizer will report a maximum of 7 digits. By default, the placement of the decimal is the same as the live flow rate. The totalizer can be configured at the time of order for the following behaviors:

- **Rollover (Default):** Totalizer resumes counting from zero as soon as the maximum count has been reached.
- **Freeze:** Totalizer stops counting at max count, until it is reset manually.
- **Error (Default):** Displays **OVR** status message when maximum count has been reached; compatible with the rollover and freeze functions.

The elapsed time counter has a maximum value of 9999:59:59 (h:m:s) (416 days, 16 hours). If flow is still being totalized at that point, the timer freezes, regardless of the behavior chosen above for the totalized flow readings.

Dispensing Gas in Batches

Batch dispensing allows you to choose a desired total volume to flow, after which the valve closes. You can repeat batches with a single button press.

Starting batch dispensing

1. From the totalizer screen, press **BATCH**. Choose the total quantity to be dispensed in each batch. Press **SET** to accept the new batch size.
2. From the totalizer screen ([page 11](#)), press **SETPT** to choose a non-zero setpoint. Flow begins as soon as you press **SET**.



Note: Batch dispensing requires an active batch size and a non-zero setpoint. If your controller already has a non-zero setpoint, flow begins as soon as you press **SET** from the batch size screen.

While a new batch is being dispensed, the **BATCH** button changes to show the quantity that remains to be dispensed. When the batch size has been achieved, the **BATCH** button displays **-DONE-** and flow stops automatically.

The batch size can be changed while a batch is in progress. If the new batch size is larger than the current totalized flow, then flow continues until the new value is reached. If the new batch size is smaller than the current totalized flow, then the flow stops immediately. Press **RESET** to start the new batch.

Repeating a batch

- For an identical, new batch, press **RESET**. Flow begins immediately.
- For a new batch of a different size, press **BATCH**, and select the new batch size. If there is a non-zero setpoint, flow will begin as soon as **SET** is pressed.

Pausing or canceling a batch

1. To stop flow while a batch is in progress, set the mass flow setpoint to 0 by pressing **SETPT** → **CLEAR** → **SET** within the **totalizer menu**. This will not stop the timer. Resume flow with a non-zero set point.
2. To remove a batch setting, press **BATCH** or **REMAIN** → **CLEAR** → **SET**. Deleting the batch does not affect the setpoint. Flow will continue at the setpoint rate.



Warning: Flow will resume immediately at the current setpoint when batch dispensing is turned off.



Note: The batch size is retained across power cycles of your flow controller. It must be manually cleared when no longer desired.

Using the Totalizer while Controlling Pressure

While using a mass flow controller to control pressure, the flow rate may exceed the maximum measurable flow (128% of full scale) with an abrupt pressure change. In this case, the totalizer will use the maximum 128% of full scale as the measured flow rate, the totalized flow value will flash, and the **TMF** error will appear to indicate that the totalizer missed flow data. Reset the totalizer to clear the error message.

Setting an upper flow limit ([page 15](#)) within the readable range will prevent this error; however, this will take preference over reaching the pressure setpoint.



Warning: In certain situations, it is possible to exceed the batch size. As an example, if the feed pressure is too low to achieve the flow setpoint and then pressure is suddenly increased, the batch size may be exceeded before the valve reacts to the sudden burst of pressure.

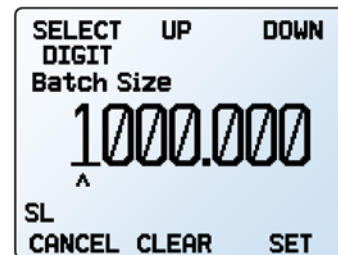

Selecting a batch size of 1000 SL.

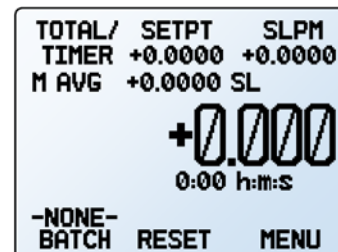

The totalizer displaying a mass flow average without a batch, with a batch in progress, and with a finished batch.

Control

Changing the Setpoint

SETPT or MENU → CONTROL → Setpt:

The setpoint selection screen indicates the engineering units and maximum allowable setpoint (e.g., **SLPM: +10.000 Max**). To cancel a setpoint, press **CLEAR**, then **SET**.

Adjusting Setpoint with an IPC

For controllers ordered with a potentiometer control knob (IPC), the setpoint source must be set to analog for the controller to receive setpoint commands from the IPC (see “Changing Between Setpoint Sources” below).

Leave the IPC knob at the midpoint when it is not in use.

Setpoint Setup

Using Autotare

CONTROL → Setpoint Setup → Zero Setpoint

When the setpoint is zero, the controller will automatically tare itself if autotare is enabled (default). This menu also specifies how many seconds after given zero setpoint the controller will wait before taring, under **Delay Before Tare**.

Setpoint ramping ([page 16](#)) can either be set to honor the ramp rate limit or go to zero as quickly as possible.

Changing Between Setpoint Sources

CONTROL → Setpoint Setup → Setpoint Source

Mass flow controllers with RS-232 or RS-485 communication will accept setpoints from the front panel and serial commands (see [page 23](#)), or from an analog signal.

- When the source is set to **Serial/Front Panel**, the controller will accept input from either the front panel, or an RS-232/RS-485 connection. Neither source is a slave of the other, so the controller will accept the most recent command from either source.
- When the source is set to **Analog**, the device ignores serial setpoint commands and will prevent setpoint input from the front panel.

Managing Setpoint with an Idle Modbus Connection

CONTROL → Setpoint Setup → On Modbus Timeout

If a Modbus connection is timed out, the device can be configured to either set a zero setpoint, or maintain the last setpoint it was given. The timeout time will be infinite by default and can be adjusted ([page 21](#)).

Managing Setpoint on Power-Up

Power Up Setpoint Value

CONTROL → Setpoint Setup → Power Up Setpoint → Value

By default, the controller remembers its last setpoint across power cycles. However, it can be changed to give a specified setpoint upon power up by selecting **Fixed Setpoint** and entering a value. If the setpoint will be digitally provided more than every few minutes, use a fixed setpoint on power-up to avoid wearing out non-volatile memory in the device.

Power Up Setpoint with Ramping

CONTROL → Setpoint Setup → Power Up Setpoint → Ramp

Any setpoint ramp will always start from zero on power-up. Similar to the zero setpoint option ([page 16](#)), the device can either honor the ramp rate (**Honor from 0**) or jump to setpoint (**Jump from 0**) as quickly as possible.

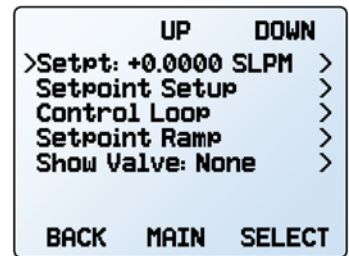

The control menu.



An IPC knob atop a controller.

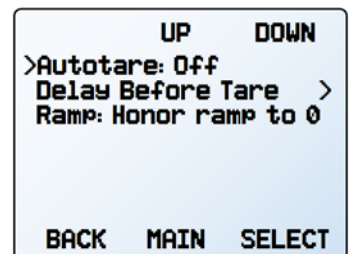

The zero setpoint (autotare) menu with Autotare off.

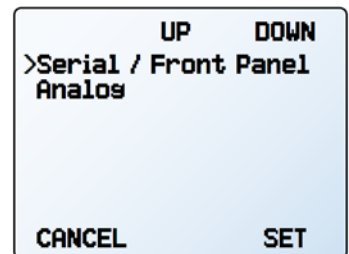

The setpoint source menu.

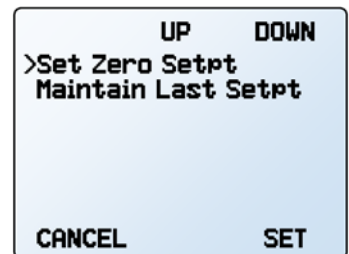

The modbus timeout menu.

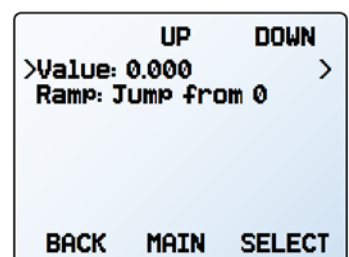

The power-up setpoint menu.

Establishing Setpoint Limits

CONTROL → Setpoint Setup → Setpoint Limits

The **setpoint limits** menu configures upper and lower limits for selecting a flow or pressure control setpoint. By default, the controller will only be limited by its measuring range; however, more strict limits may be beneficial in certain critical applications.

Over a serial connection, requesting a setpoint outside the limit will be rejected and an error will be returned. When using an analog setpoint signal, setpoints that are outside of the setpoint limits are treated as if they were at the nearest limit. For example, if you request a setpoint that is below the lower limit, the controller sets the setpoint at the lower limit.

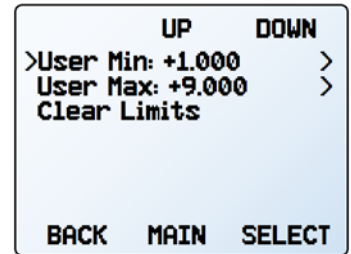

The setpoint limits menu.



Warning: Flow controllers that have non-zero lower setpoint limits cannot be set to stop flow until the lower limit has been cleared.



Note: When changing from one control loop variable to another, the flow controller remembers setpoint limits as percentages of full scale. For example, a 10-SLPM limit on a 20-SLPM controller (50% of full scale) will become a limit of 80 PSIA (50% of 160 PSIA) if the control loop is changed to absolute pressure.

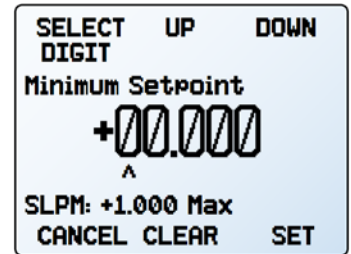

Setting a minimum setpoint.

Control Loop

Changing the Controlled Variable

CONTROL → Control Loop → Control

The controller can control the flow rate or the pressure in your process. Selectable control loop variables include mass flow, volumetric flow, absolute pressure, and valve drive. Devices with internal barometers also allow control of gauge pressure.



Note: When pressure is selected as the control loop variable, flow controllers with upstream valves will control the outlet pressure. Those with downstream valves can control upstream back pressure, but these must be configured for this type of control.



Warning: When changing the control loop from mass or volumetric flow to absolute or gauge pressure, you may need to adjust the PID settings for optimal stability and speed of response.

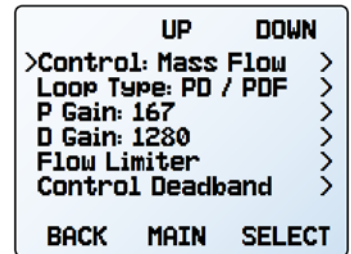

The control loop menu in PD/PDF control mode.

Adjusting the PD/PDF or PD²I Control Algorithms

CONTROL → Control Loop → Loop Type

Your mass flow controller uses an electronic closed loop controller to determine how to actuate its valve(s) in order to achieve the commanded setpoint. These settings were tuned for your specific operating conditions, but changes to your process sometimes require on-site adjustments to maintain optimal control performance. Fine-tuning your closed loop control may help correct issues with control stability, oscillation, or speed of response.

For most applications, the PD/PDF algorithm is recommended. When controlling pressure with an MCD dual valve controller, the PD²I algorithm is recommended.

Tuning the PD/PDF control algorithm

The controller's default control algorithm (PD) employs pseudo-derivative feedback (PDF) control, which uses two editable variables:

- The larger the **D** gain, the slower the controller will correct errors between the commanded setpoint and the measured process value. This is equivalent to the **P** variable in common PDF controllers.
- The larger the **P** gain, the faster the controller will correct for offsets based on the size of the errors and the amount of time they have occurred. This is equivalent to the **I** variable in common PDF controllers.



Note: The **D** and **P** variables in the PD/PDF control algorithm are more typically referred to as **P** and **I**, respectively, in PDF controllers.

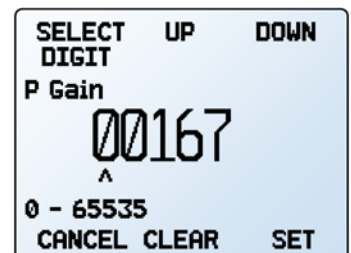

Setting a P Gain.

Tuning the PD²I Control Algorithm

The controller's PD²I control algorithm (also called PDDI) is used to provide faster response, most commonly in dual-valve flow and pressure controllers. This algorithm uses typical PI terms and adds a squared derivative term (D):

- The larger the **P** gain, the more aggressively the controller will correct errors between the commanded setpoint and the measured process value.
- The larger the **I** gain, the faster the controller will correct for offsets based on the size of the errors and the amount of time they have occurred.
- The larger the **D** gain, the faster the controller will predict needed future corrections based on the current rate of change in the system. This often results in slowing the system down to minimize overshoot and oscillations.

	UP	DOWN
>Control: Mass Flow	>	
Loop Type: PD2I	>	
P Gain: 167	>	
I Gain: 1280	>	
D Gain: 10	>	
Flow Limiter	>	
Control Deadband	>	
BACK MAIN SELECT		

The control loop menu in PD²I control mode.

Troubleshooting Valve Performance with PID Tuning

The following issues can often be resolved by adjusting the PID gain values for your mass flow controller.

Fast oscillation around the setpoint

- PD: Reduce the **P** gain in decrements of 10%.
- PD²I: Increase the **P** gain in increments of 10%, and then adjust the **I** gain to fine-tune.

Overshot setpoint

- PD: Reduce the **P** gain in decrements of 10%.
- PD²I: If **D** is not 0, increase the **P** gain in increments of 10%.

Delayed or unattained setpoint

- PD: Increase the **P** gain in increments of 10%, and then decrease the **D** gain by small amounts to fine-tune.
- PD²I: Increase the **P** gain in increments of 10%, and then increase the **I** gain to fine-tune.



Valve tuning can be complex. More detailed information is available at alicat.com/pid.

Limiting Flow Rate While Controlling Pressure

CONTROL → Control Loop → Flow Limiter

Limiting the flow rate while controlling pressure can help to avoid exceeding the measurable range of the device as well as prevent damage of sensitive devices later in the process. To limit flow:

1. Choose either mass flow or volumetric flow to limit by pressing **TYPE**.
2. Set the maximum value of flow rate desired by pressing **MAX FLOW** and entering the maximum value in the engineering units displayed.
3. Set the **Limiter Gain** to 500 and adjust as needed. **Limiter gain** determines how aggressively the proportional control function will correct the error when the flow rate exceeds the maximum flow setting. A higher value will correct more aggressively, but is also more likely to oscillate near the flow limit.



Note: If both flow limiting and pressure setpoint ramping are active when controlling pressure, the more restrictive function will regulate the controller's operation as it attempts to attain the setpoint.



Note: For bidirectional controllers, the flow limit will be symmetric. For example an MCD-20SLPM with a maximum set to 10 SLPM will be limited to between -10 slpm and 10 slpm.

	UP	DOWN
>Type: Mass Flow	>	
Max Flow: None	>	
Limiter Gain: 0	>	
BACK MAIN SELECT		

The flow limiter menu.

SELECT	UP	DOWN
DIGIT		
Max Flow Limit		
+0.0000		
^		
SLPM: +1.0000 Max		
CANCEL CLEAR SET		

Setting a maximum flow limit.

Using a Control Deadband for Pressure Control

CONTROL → Control Loop → Control Deadband

The control deadband is designed to minimize the amount of gas exhausted and improve stability. There is no active control within the deadband setting.



Note: A control deadband cannot be set when the device is configured to control flow (the **Control** menu item within the **control loop menu**, see [page 14](#)). If control is set to mass flow, the error, **Only active when controlling pressure** will show instead of the **deadband menu**.

To turn on the control deadband, enter a non-zero value in **CONTROL → Control Deadband → Deadband**. The controller must first reach the setpoint for the deadband to activate. If the process variable drifts outside a deadband limit, active control resumes until the setpoint is reached again.

The controller can be set to either hold the current valve position or close the valve(s) in **CONTROL → Control Loop → Control Deadband → When in Band**. It is recommended to hold the current position on MC-Series devices and close valves for MCD-Series devices.

Example: With a setpoint of 30 PSIA, a deadband of ± 0.25 PSIA allows absolute pressure to vary between 29.75 and 30.25 PSIA. The device will hold the current valve position until the pressure reading varies outside of the preset deadband.



Caution: MC-Series devices do not have an exhaust valve to reduce pressure when pressure exceeds the deadband.

Setpoint Ramping

Setpoint ramping regulates how quickly the controller will reach the flow or pressure setpoint. It is often used to prevent bursts of pressure or flow from damaging delicate instruments when starting a process.

To activate setpoint ramping, you will set a maximum ramp rate and configure when to enable the ramping function.

Setting the Ramp Rate

- **Ramp** is a quick way to change the maximum rate of change.
- **Units** is a quick way to change the engineering units used.
- **Set By Delta / Time** allows for more detailed control of the ramp rate including changing the value of the time period.

Ramping Options

Changing ramping options allows you to have a ramp in only one direction, increasing or decreasing. It also allows you to ignore the ramp rate when initially powering on or commanding a zero setpoint.

- **Ramp Up** can toggle between on and off. When off, the ramp rate will not be honored when increasing flow to reach a given setpoint.
- **Ramp Down** can toggle between on and off. When off, the ramp rate will not be honored when decreasing flow to reach a given setpoint.
- **Power Up** toggles between **Allow Ramp** and **No Ramp**. If set to **No Ramp**, the device will ignore the ramp rate just after powering on, otherwise it will honor the ramp rate from a zero setpoint.
- **0 Setpt** determines whether the controller ramps when a zero setpoint has been given. If this setting is set to **No Ramp**, when given a zero setpoint, the controller will immediately snap to the zero setpoint; otherwise it will ramp at the selected rate.



Note: Setpoint ramping can be used with flow or pressure setpoints, depending on the control loop selected. Ramping for pressure control limits how quickly pressure changes before reaching the setpoint. To limit flow rates directly while controlling pressure, see [page 15](#).

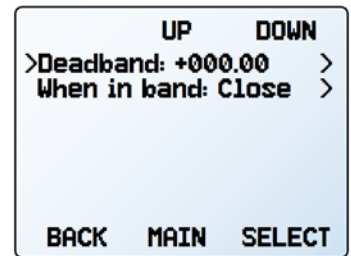

The deadband menu.

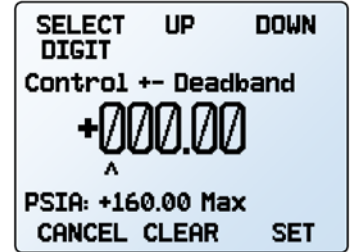

Choosing deadband size.

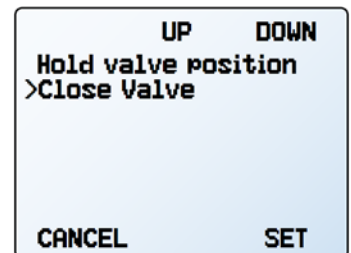

Choosing deadband options.

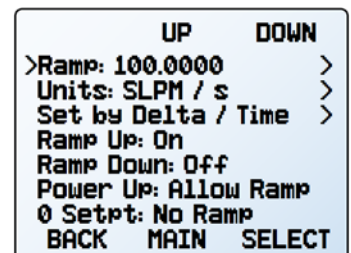

The setpoint ramping menu.

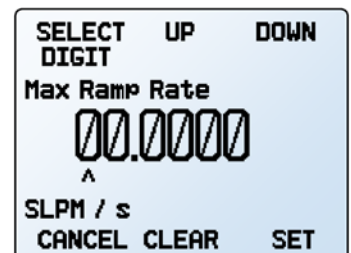

Setting a maximum ramp rate.

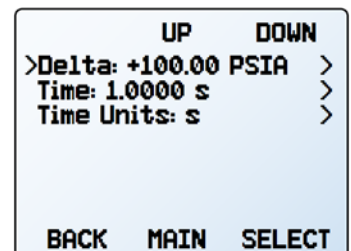

Configuring delta/time ramping.

Displaying Valve Drive Percentage

The valve drive is represented as a percentage of the amount of voltage driven to the valve. Percentages do not directly correlate with percentage open.

Viewing the valve drive percentage is particularly helpful for troubleshooting. An increase in percentage over time likely indicates a clog in the system where more voltage is required to drive the valve to attain the same amount of flow. A valve percentage of 0% indicates the valve is not open.

This information may be displayed on the **main display** and/or as part of transmitted serial data. There are four valve display options:

- **None:** No valve information is displayed.
- **Main Screen:** Only on the **main display**.
- **Digital Data:** Only in the serial data frame.
- **Screen and Digital:** Both the **main display** and serial data frame.

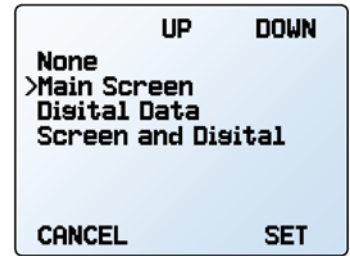

The valve display menu

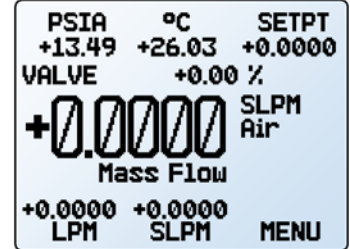

Valve percentage on the **main display**, above the large numbers.

Device Information

The **ABOUT** menu (**MENU** → **ABOUT**) contains useful information for setup, configuration, and troubleshooting.

Basic Device Information

ABOUT → **About Device**

This includes information on the following:

- **MODEL:** Device model
- **SERIAL NO:** Serial number
- **DATE MFG:** Manufacturing date
- **DATE CAL:** Most-recent calibration date
- **CAL BY:** Initials of the person who calibrated the device
- **SW:** Firmware version
- **Display SW** (color displays only): Firmware version of the display

Device Full Scale Ranges

ABOUT → **Full Scale Ranges**

This displays the maximum calibrated range of available flow and pressure readings. Most will include mass flow, volumetric flow, and absolute pressure. Devices equipped with an optional barometer will also show gauge and barometric pressures.

Manufacturer Information

ABOUT → **About Manufacturer**

About Manufacturer usually includes:

- Manufacturer name
- Web address
- Phone number
- Email address

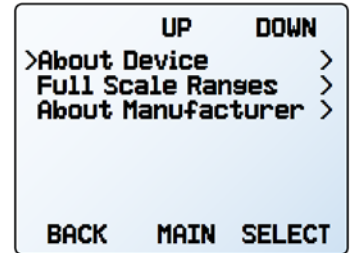

The **about** menu.

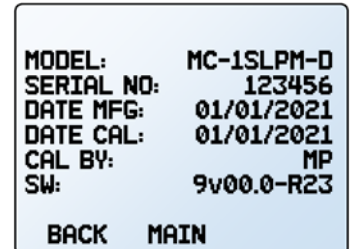

The **about device** screen.

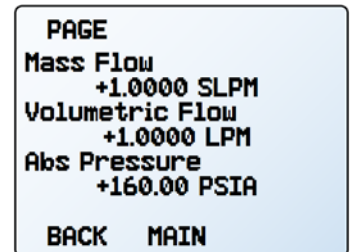

The **full scale ranges** screen.

Setup

Gas Selection

MENU → SETUP → Active Gas

Gas Select™

In most cases, your flow controller was physically calibrated at the factory using air. Gas Select™ allows you to reconfigure the flow controller to flow a different gas without any need to send it back for a physical recalibration.

Within this menu, there are a variety of categories (such as **Standard**, **Chromatography** and **Welding**), as well as recent selections, and COMPOSER™ mixes (see next page). Each category will list a subset of available gases and preconfigured mixtures.

As soon as you press **SET** from the gas list, your flow controller will reconfigure its flow rate calculations to the newly selected gas's properties. There is no need to restart the device.

Your current gas selection appears just below the unit's indicator on the right side of the main display (see [page 10](#)).

Category and Gas List Controls

- **PAGE** advances the view to the next page of categories or gases.
- **SELECT** (in the category list) opens a list of gases in that category.
- **SET** (in the gas list) immediately loads the gas measurement properties and exits to the setup menu.

Using COMPOSER™ Gas Mixes

SETUP → Active Gas → COMPOSER Mixes

To remain accurate, your flow controller needs to reference the viscosity of the gas you are flowing through it. The more closely you can define your actual gas composition, the more accurate your flow readings will be. COMPOSER™ is an included feature of Gas Select™ that lets you define new mixed gas compositions to reconfigure your flow controller on the fly.

Wilke's semi-empirical method is used to define a new gas mixture based on the molar (volumetric) ratios of the gases in the mixture. You can define these gas compositions to within 0.01% for each of up to five constituent gases in the mixture. Once you define and save a new COMPOSER™ gas mix, it becomes part of the Gas Select™ system and is accessible under the gas category **COMPOSER User Mixes**. You can store up to 20 COMPOSER™ gas mixes on your flow controller simultaneously.



Note: The COMPOSER™ is device firmware, and does not physically mix gases. It only configures the device's calculations to report flow readings more accurately based on the constituent gases of your defined mixture.

Select any existing mix and press **SET** to immediately configure your device to measure that gas mixture. To create new mixes, see the next section.

	UP	DOWN
>Active Gas: Air		>
Sensor		>
RS-232 Serial		>
Display		>
Advanced		>
BACK	MAIN	SELECT

The setup menu.

	PAGE	UP	DOWN
>Recent			>
Standard			>
COMPOSER Mixes			>
Bioreactor			>
Breathing			>
Chromatography			>
Fuel			>
BACK	MAIN	SELECT	

The first page of the Gas Select™ category list.

	PAGE	UP	DOWN
>Air			
Ar Arson			
CH4 Methane			
CO Carbon Monoxide			
CO2 Carbon Dioxide			
C2H6 Ethane			
H2 Hydrogen			
CANCEL	INFO	SET	

The Gas Select™ standard gas list.

Creating New Mixes in COMPOSER™

SETUP → Active Gas → COMPOSER Mixes → Create Mix

Give the Mix a Short and Long Name

UP/DOWN will change the character. Valid characters include A–Z, 0–9, punctuation (., -), and space. CANCEL exits to the mix settings menu. SET accepts the name.



Note: Using a space in the short name can cause the serial data frame to be read incorrectly by some programs.

```
                UP      DOWN
>Save Mix
Short Name:    >
Name:         >
Add Gas to Mix >
Total 0.00%
Gas Number: 255
BACK  MAIN  SELECT
```

The mix settings menu.

Define the Mix.

- Add Gas to Mix enters the Gas Select™ category listing. Once you find the correct gas, press SET. Enter the composition percentage and press SET.
- As gases are added, the total used percentage will be shown on the mix settings menu.
- Once gases have been added, COMPOSER™ can change the gas percentage to fill the remaining portion to 100% by selecting the component gas, then selecting Set % to Balance.
- The mixture can be saved when its gases total 100% by selecting Save Mix. Selecting BACK will permanently discard the mix.

```
SELECT  UP      DOWN
LETTER
Mix name
      Gas 1-1 H2C2 Mix
      -----A
                CHANGE
CANCEL CASE  SET
```

Defining a mixture's long name.

```
                UP      DOWN
>Create Mix: 20 Free >
BACK  MAIN  SELECT
```

The COMPOSER™ menu without existing mixes.

```
SELECT  UP      DOWN
DIGIT
C2H2 Acetylene Percen
      50.00
      ^
%: 0.01 - 99.99
CANCEL CLEAR  SET
```

Setting the percentage of a constituent gas C₂H₂.

```
                UP      DOWN
>Save Mix
Short Name: Gas1-1 >
Name: Gas 1-1 H2C2 Mi >
Add Gas to Mix >
Total 50.00%
C2H2: 50.00% >
Gas Number: 255
BACK  MAIN  SELECT
```

The results of the addition of C₂H₂.

```
                UP      DOWN
>Gas 1-1 H2C2 Mix
Create Mix: 19 Free >
BACK  MAIN  SELECT
```

The COMPOSER™ menu with the new custom mix.

- Mixes that contain several gases will push the menu to a second page; use the PAGE button to see the remaining list.

Viewing, Deleting, and Creating Similar Mixes

SETUP → Active Gas → COMPOSER Mixes → [Select mix] → INFO

The current configuration of any existing COMPOSER™ mix can be viewed by selecting INFO instead of SET in the mix list. It will show:

- Options to delete the mix, or to create a similar mix.
- Short and long names.
- The gas number.
- The composition, which may extend to a second page; if so, pressing the PAGE button will move to the next page.

Sensor Setup

MENU → SETUP → Sensor

Choosing Engineering Units

SETUP → Sensor → Engineering Units

Changing engineering units alters both the display and the data frame. Choose the parameter whose unit you want to change, and then choose an engineering unit, confirming the change on the last screen.

Defining STP/NTP Reference Values

SETUP → Sensor → STP Flow Ref or NTP Flow Ref

Standardized flow rates are reported in “standard” or “normal” volumetric flow units that reference a given temperature and pressure combination. This reference is called STP (standard temperature and pressure) or NTP (normal temperature and pressure). Depending on the engineering units selected, either STP or NTP will be editable from this menu.

Reference options:

- **Stan T:** Standard Temperature
- **Stan P:** Standard Pressure
- **Norm T:** Normal Temperature
- **Norm P:** Normal Pressure
- **Ref temp units** changes the temperature units used for STP and NTP calculations.
- **Ref pressure units** changes the pressure units used for STP and NTP calculations

Unless otherwise requested, your flow controller ships with a default STP of 25°C and 1 atm (which affects flow units beginning with “S”), and an NTP of 0°C and 1 atm (which affects flow units beginning with “N”).



Warning: Changes to STP or NTP references will alter your mass flow readings.

Flow and Pressure Averaging

SETUP → Sensor → Flow Averaging

SETUP → Sensor → Pressure Averaging

Averaging the flow over a longer time may be useful in smoothing fluctuating readings. This menu changes the time constants of the geometric running averages for flow and pressure. Values roughly correspond to the time constant (in milliseconds) of the averaged values. Higher numbers generate a greater smoothing effect, to a maximum of 255 ms.

Zero Band

SETUP → Sensor → Zero Band

The zero band threshold is an amount of flow under which flow values are displayed as 0. The maximum zero band is 6.38%. This function also applies to gauge pressure readings when using the optional barometer. For example, a 20 SLPM controller with a zero band value of 0.25% would display as 0 SLPM for all readings below 0.05 SLPM.

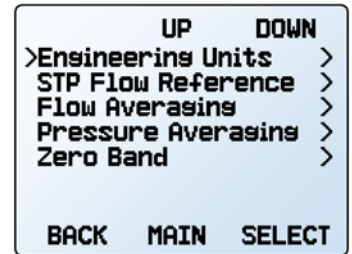

The sensor setup menu.

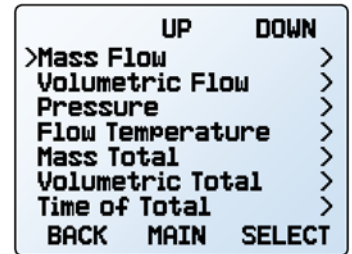

The engineering units menu, including units for the totalizer (page 11).

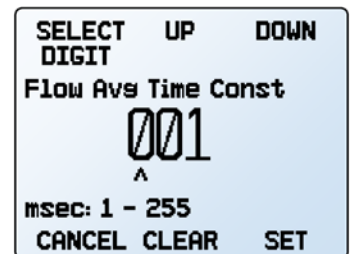

Adjusting the flow averaging time constant.

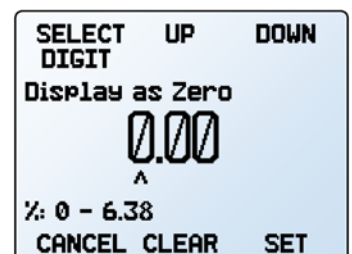

Configuring the zero band.

Configuring Serial Communications

MENU → SETUP → RS-232 Serial or RS-485 Serial

You can operate the flow controller remotely via its data connection for easy streaming and logging of all data. Before connecting the flow controller to a computer, ensure that it is ready to communicate with your computer by checking the options in this menu.

For more on how to issue commands from a computer, see [page 23](#).

Unit ID

SETUP → RS-232 Serial or RS-485 Serial → Unit ID

The unit ID is the identifier that a computer uses to distinguish your device from other, similar devices when it is connected to a network. Using the unit ID letters A–Z, you can connect up to 26 devices to a computer at the same time via a single COM port. This is called **polling mode** ([page 23](#)). Unit ID changes take effect when you select SET.

If you select “@” as the Unit ID, the flow controller will enter **streaming mode** when you exit the menu ([page 23](#)).

Modbus RTU Configuration

SETUP → RS-232 Serial or RS-485 Serial → Modbus Address

SETUP → RS-232 Serial or RS-485 Serial → Modbus

Modbus Address

The Modbus address is the identifier that a computer or programmable logic computer (PLC) uses to distinguish your device from other devices when connected to a Modbus network. Values of 1–247 are available for use.

Managing Setpoint with an Idle Modbus Connection

If a Modbus connection is idle for a specified amount of time, the device can be configured to set a zero setpoint, or maintain the previous setpoint. The idle time will be infinite by default and can be set in seconds up to 99999.9 seconds (1 day, 3 hours, 46 minutes, 39.9 seconds).

Baud Rate

SETUP → RS-232 Serial or RS-485 Serial → Baud Rate

Baud rate is the speed at which digital devices transfer information. The flow controller has a default baud rate of 19200 baud (bits per second). If your computer or software uses a different baud rate, you must change the flow controller’s baud rate in the **BAUD** menu to ensure they match. Alternatively, you can change your computer’s baud rate in Windows® Device Manager. Baud rate changes take effect once you press **SET**, but you may need to restart the software for it to recognize the change.

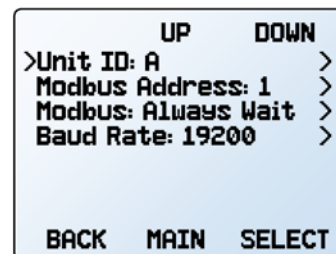

The serial communication menu.

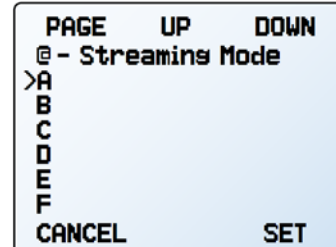

Choosing a unit ID, or streaming.

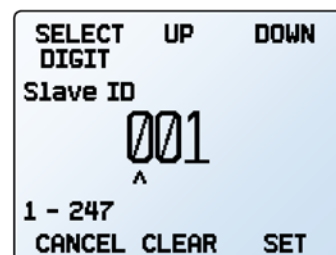

The Modbus address menu.

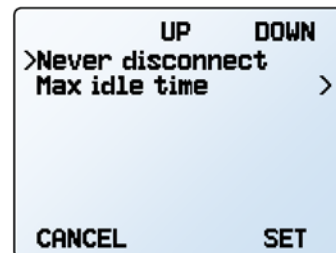

The Modbus idle menu.

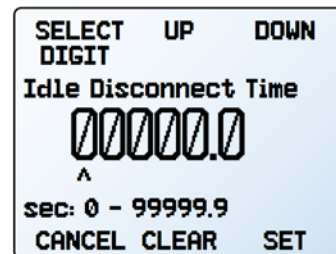

Setting a Modbus idle disconnect time.

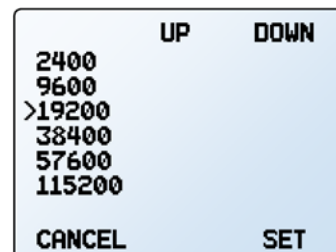

Baud rate options.

Display Setup

MENU → SETUP → Display

The options in the **display setup menu** adjust the contrast/brightness of the display and enable screen rotation.

Main Screen Options

SETUP → Display → MAIN Screen

- **Any Key Press** changes what happens when any of the parameter buttons on the main display ([page 10](#)) are pressed (pressure or temperature, for example). By default, these buttons highlight their measurement in the center of the display. If this option is set to **Show Actions Menu**, an option to change that parameter's engineering units will be shown, as well as an option to highlight the parameter.
- **Show Valve Drive** shows or hides the valve's drive percentage. See [page 17](#).
- **Top Left Key Value** will show if the device has an optional barometer installed. This option configures which type of pressure (barometric, gauge, absolute) is displayed.

Screen Lighting

SETUP → Display → Screen Lighting

The options and wording in the **screen lighting menu** will vary for monochrome versus color displays.

- On monochrome displays, press **LESS CONTRAST** or **MORE CONTRAST** to adjust the contrast levels and move the contrast indicator left or right. **POWER UP Lit** or **Dark** toggles whether the backlight of the unit will be on when the device powers on.
- On color displays, press **LESS BRIGHT** or **BRIGHTER** to adjust the brightness level and move the brightness indicator left or right.

Display Rotation

SETUP → Display → Display Rotation

The device has the option of inverting (flipping) the screen upside-down, as configured in this menu.

Advanced Setup

MENU → SETUP → Advanced

The **advanced setup menu** contains settings and detailed information that are useful when troubleshooting with customer support.

Factory Restore

SETUP → Advanced → Factory Restore

This will immediately take you to a confirmation screen. When troubleshooting, an applications engineer may recommend doing a **Factory Restore**. If something is not acting as expected, please contact an applications engineer prior to doing a **Factory Restore**.

Register Status

SETUP → Advanced → Register Status

The **Register Status** screen displays live values for the internal device registers. Many of these values can help an applications engineer diagnose operational issues over the phone. Some register values clearly distinguish between hardware and operational problems, which speeds up the troubleshooting process.

Edit Register and Device Properties

SETUP → Advanced → Edit Register

SETUP → Advanced → Device Properties



Warning: Editing these settings may cause the device to become inoperable. Do not modify them without working with an applications engineer.

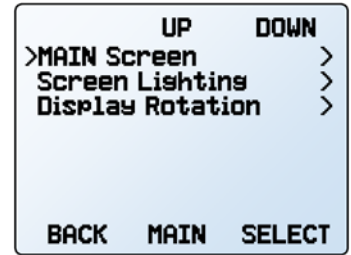

The display setup menu.

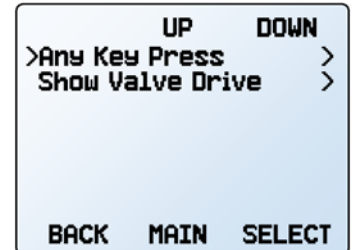

The options for pressing buttons on the main display.

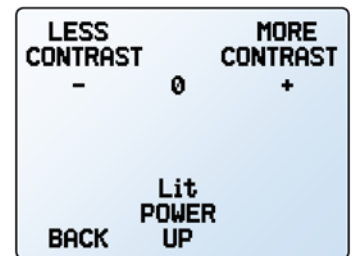

The monochrome contrast menu.

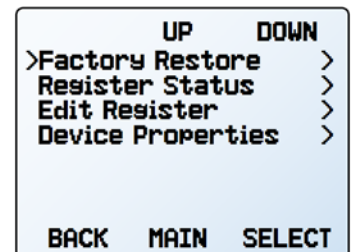

The advanced setup menu.

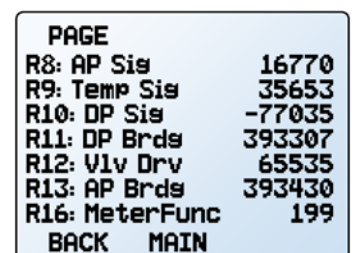

The register status list.

Serial Communication

Connecting your device to a computer allows you to log the data that it generates. The device communicates digitally through its communications connector and cable using a real or virtual COM port on your computer. This section of the manual shows you how to operate the flow controller using ASCII commands.

Modbus RTU Communication

For details on Modbus commands, please visit alicat.com/manuals for the Modbus operating bulletin.

Establishing Communication

After connecting your device using a communications cable, you will need to establish serial communications through a real or virtual COM port on your computer or programmable logic computer (PLC).

- If you have connected your device to a serial port, note its COM port number, which can be found in the Windows® Device Manager program.
- If you have used a USB cable to connect your device to your computer, then in most cases it will recognize your USB as a virtual COM port. If it does not, download the appropriate USB device driver at alicat.com/drivers and note the COM port number as found in Windows® Device Manager.

The controller will be configured with the following settings:

- **Baud:** 19200 (by default; others can be used if the computer, software, and the controller are all set to the same rate)
- **Data bits:** 8
- **Parity:** none
- **Stop bits:** 1
- **Flow control:** none

Alicat's Serial Terminal Application

Alicat's Serial Terminal is a preconfigured program for serial communications, functioning much like the older Windows® HyperTerminal, with plain text in a command-line format.

Download Serial Terminal for free at alicat.com/drivers. Once downloaded, simply run SerialTerminal.exe. Enter the COM port number to which your device is connected and the baud rate of the flow controller. The default baud rate is 19200, but this is adjustable by entering the **RS-232 Serial** menu on your flow controller ([page 21](#)).

 **Note:** In the following, ↵ indicates an ASCII carriage return (decimal 13, hexadecimal D). For many devices, this is the same as hitting the Enter key. Serial commands are not case-sensitive.

Polling Mode

Your device was shipped in polling mode with a unit ID of A, unless requested otherwise. Polling the device returns a single line of data each time you request it. To poll your device, simply enter its unit ID.

Poll the device: [unit ID]↵

Example: a↵ (polls unit A)

You can change the unit ID of a polling device by typing:

Change the unit ID: [current unit ID]@[desired unit ID]↵

Example: a@=b↵ (changes unit A to unit B)

You can also do this via the device's front panel menu ([page 21](#)). Valid unit IDs are letters A–Z, and up to 26 devices may be connected at any one time, as long as each unit ID is unique.

Streaming Mode

In streaming mode, your device automatically sends a line of live data at regular intervals. Only one unit on a given COM port may be in streaming mode at a time. To put your device into streaming mode, type:

Begin streaming: [unit ID]@=@
Example: a@=@ (puts device A into streaming mode)

This is equivalent to changing the unit ID to “@”. To take the flow controller out of streaming mode, assign it a unit ID by typing:

Stop streaming: @@=[desired unit ID]
Example: @@=a (stops and assigns unit ID of A)

When sending a command to a device in streaming mode, the flow of data will not stop while the user is typing. This may make the commands you type unreadable. If the device does not receive a valid command, it will ignore it. If in doubt, simply hit `↵` and start again.

The default streaming interval is 50 ms. This can be increased by changing Register 91 while the device is in polling mode:

Set streaming interval: [unit ID] w91=[number of ms]
Example: aw91=500 (streams new data every 500 ms)

Taring

Before collecting flow data, be sure to tare your controller. If auto-tare is enabled, this can be accomplished by providing a setpoint of 0 for at least 2 seconds.

Manual taring can be accomplished through two separate commands for flow and pressure. Taring flow sets the zero flow reading and must be done when no flow is passing through the flow controller:

Tare flow: [unit ID]v
Example: av (sets flow reading to zero)

For devices equipped with a barometer, the second tare aligns the internal absolute pressure sensor with the current barometer reading and must be done with the flow controller open to atmosphere:

Tare absolute pressure: [unit ID]pc
Example: apc (aligns internal pressure to barometer)

Collecting Data

Collect live flow data by typing the [unit ID] `↵` command or by setting your flow controller to streaming. Each line of data for live flow measurements appears in the format below, but the unit ID is not present in streaming mode.

A	+13.542	+24.57	+16.667	+15.444	+15.444	N2
ID	Absolute Pressure	Temperature	Volumetric Flow	Mass Flow	Setpoint	Gas

Single spaces separate each parameter, and each value is displayed in the chosen device engineering units (see [page 20](#)). You can query the engineering units of the serial data frame by typing:

Query live data info: [unit ID]??d*
Example: a??d* (returns the data frame descriptions)

Additional columns, including status codes (see [page 6](#)), may be present to the right of the gas label column. The unit ID appears in the data frame only when the flow controller is in polling mode.

Commanding a New Setpoint

Before attempting to send a setpoint to your controller serially, confirm that its setpoint source is set to **Serial/Front Panel1** (see [page 13](#)).

There are two ways to command a new setpoint over a serial connection, as described below. In either of these methods, the data frame returns the new setpoint value when it has been accepted as a valid setpoint.

Sending Setpoints as Floating Point Numbers

This is how to send the desired setpoint value as a floating point number in the engineering units selected:

New setpoint: [unit ID]s[floating point number setpoint]↵

Example: as15.44↵ (setpoint of +15.44 SLPM)

When using a bidirectional mass flow controller, negative setpoints are sent by adding a hyphen for the minus sign (-):

Example: as-15.44↵ (setpoint of -15.44 SLPM)

Using Gas Select™ and COMPOSER™

To reconfigure your flow controller to flow a different gas, look up its gas number (see [page 29](#)). For more information on how Gas Select™ and COMPOSER™ work, see [page 18](#). Here are the commands:

Choose a gas: [unit ID]g[Gas Number]↵

Example 1: ag8↵ (reconfigures to flow nitrogen)

Example 2: ag206↵ (reconfigures to flow P-10)

User mixes are selected in the same way. All COMPOSER™ gas mixes have a mix number between 236 and 255.

Choose a user mix: [unit ID]g[Gas Number]↵

Example: ag255↵ (reconfigures for user mix 255)

Defining a new COMPOSER™ gas mix is faster using serial commands than using the front panel. The basic formula for this is:

[unit ID]gm [Mix Name] [Mix Number] [Gas1 %] [Gas1 Number] [Gas2 %] [Gas2 Number]...↵

[Mix Name] Use a maximum of 6 letters (upper and/or lower case), numbers and symbols (period or hyphen only). This is equivalent to the short name when creating a mix via the front panel ([page 19](#)).

[Mix Number] Choose a number from 236 to 255. If a user mix with that number already exists, it will be overwritten. Use the number 0 to assign the next available number to your new gas. Gas numbers are assigned in descending order from 255.

[Gas1 %] [Gas1 Number]... For each gas, enter its molar percentage up to 2 decimal places, then its gas number ([page 29](#)). 2–5 gases are required, and the sum of all gas constituent percentages must equal 100.00%. After creating a mix, the controller will confirm the new gas:

Example 1: Create a mix of 71.35% helium, 19.25% nitrogen, and 9.4% carbon dioxide as Gas 252, called “MyGas1”.

Command: agm MyGas1 252 71.35 7 19.25 8 9.4 4↵

Response: A 252 71.35% He 19.25% N2 9.40% C02

Example 2: Create a mix of 93% methane, 3% ethane, 1% propane, 2% nitrogen, and 1% CO2, using the next available gas number, called “MyGas2”.

Command: agm MyGas2 0 93 2 3 5 1 12 2 8 1 4↵

Response: A 253 93.00% CH4 3.00% C2H6 1.00% C3H8 2.00% N2 1.00% C02

Quick Command Guide

Serial commands are not case-sensitive

Change the unit ID: [unit ID]@[desired ID]↵
Tare flow: [unit ID]v↵
Tare absolute pressure
with barometer: [unit ID]pc↵ (barometers are optional)
Poll the live data frame: [unit ID]↵
Begin streaming data: [unit ID]@=@↵
Stop streaming data: @@=[desired unit ID]↵
Set streaming interval: [unit ID]w91=[# of ms]↵
New setpoint: [unit ID]s[floating point #]↵
New setpoint: [unit ID][integer]↵
Hold valve(s) at current position: [unit ID]hp↵
Hold valve(s) closed: [unit ID]hc↵
Cancel valve hold: [unit ID]c↵
Query gas list info: [unit ID]??g*↵
Choose a different gas: [unit ID]g[Gas Number]↵
New COMPOSER mix: [unit ID]gm [Mix Name] [Mix #] [Gas1 %] [Gas1 #] [Gas2 %] [Gas2 #]...↵
Delete COMPOSER mix: [unit ID]gd [Mix #]↵
Query live data info: [unit ID]??d*↵
Manufacturer info: [unit ID]??m*↵
Firmware version: [unit ID]??m9↵ or ave↵
Lock the front display: [unit ID]l↵
Unlock the display: [unit ID]u↵



If you require more advanced serial communication commands, please download the serial primer at alicat.com/drivers.

Troubleshooting

If you run into trouble with installation or operation, get in touch with support ([page 2](#)).

General Use

Issue: *My device does not turn on, or has trouble staying on.*

Action: Check power and ground connections. Please reference the technical specifications to ensure you have the proper power for your model.

Issue: *The buttons do not work, and the screen shows LCK.*

Action: The flow controller buttons were locked out via a serial command ([unit ID]1←). Press and hold all four outer buttons to unlock the interface.

Issue: *I can't read the display easily.*

Action: During the day, you can increase the visibility of the display by increasing the contrast or brightness ([page 22](#)). For monochrome displays under low-light conditions, push the bottom central button (located below the display) to turn on the backlight.

Issue: *The analog output signal indicates values lower than what appears on my instrument's display.*

Action: Analog signal voltage degrades over long distances. You can minimize this effect by using wires with a heavier gauge, especially in the ground wire.

Issue: *How often do I need to calibrate my device?*

Action: Annual recalibration is recommended. Check your device's last calibration date by selecting **MENU** → **ABOUT** → **About Device**. If it is time to recalibrate, request a recalibration from customer support ([page 2](#)).

Issue: *I dropped my device. Is it OK? Do I need to recalibrate?*

Action: If it turns on and appears to respond normally, then it is probably OK. It may or may not need a recalibration. Give it a tare, and compare it against a known-good flow standard. If it checks out, keep using it, but tell us about the drop at your next annual recalibration so we can check it out for you.

Issue: *How can I see readings in different units?*

Action: From the main menu, select **SETUP** → **Sensor** → **Engineering Units**. From this menu, you can adjust any variable's units. For more information, see [page 20](#).

Flow Readings

Issue: *The live flow readings won't settle down.*

Action: The device is very fast, so it can detect subtle variations in flow that may go unnoticed by your other devices. This sensitivity can help detect problems with pumps or flow controllers. You can lessen this sensitivity by increasing the flow averaging ([page 20](#)). Controllers use PD or PD²I control loop algorithms to reach the setpoint given. These parameters are adjustable in the field. See [page 15](#) for a quick guide on tuning.

Issue: *My controller won't reach its setpoint.*

Action: The flow rate is related linearly to the pressure drop across the device. If there isn't enough of a pressure difference between the inlet and outlet, the controller may not be able to reach setpoint. Often, increasing the inlet pressure will fix this issue.

If increasing the pressure doesn't help, check to see if there is a clog. Teflon tape can often get stuck in the flow channel and block flow. Make sure to clean out any loose Teflon tape and never tape the first two threads entering the device to help avoid this issue.

Issue: *My flow readings are negative.*

Action: Set a zero setpoint to see if the flow returns to 0 after 2 seconds. Under conditions of no flow, a negative flow reading can indicate a poor tare. Ensure that auto tare is enabled and give the controller a zero setpoint for at least 2 seconds.

Issue: *Does the controller work if it is laying down? Will it be accurate?*

Action: For small valve controllers, the answer is yes to both! The flow controller is internally compensated for any changes in orientation and can be used sideways, on its back, or upside-down. Corrosive-resistant devices should be tared again after changing orientation. Large-valve controllers should be operated with the valve cylinder vertical and upright.

Issue: *Can I put the flow controller on top of a vibrating device? Will it be accurate?*

Action: For small valve controllers, yes you can. The device is internally compensated for any changes in orientation; however, sensor noise will increase if the flow controller is vibrating. Large-valve controllers are not recommended for use on vibrating surfaces.

Issue: *My controller does not agree with another mass flow meter I have in line.*

Action: Check the STP or NTP settings (MENU → SETUP → Sensor → STP / NTP Flow Ref) to ensure that your standardized temperature and pressure references match those of your other flow calibrator. Also check that your device's Gas Select™ is set to the right gas or mixture.

Issue: *My flow readings won't change when flow changes.*

Action: If your flow readings won't change regardless of actual flow, your flow sensor may be damaged. Please contact support to troubleshoot (page 2).

Issue: *Can I use the controller with other gases?*

Action: Yes! Your flow controller is designed specifically to work with many different gases. Gas Select™ (MENU → SETUP → Active Gas) includes up to 130 preloaded gases and gas mixes, or you can define your own using COMPOSER™ (page 18). If your desired gas is not listed on page 29, please contact support to ensure compatibility (page 2).

Serial Communications

Issue: *I can't communicate to the device when it is connected to my PC.*

Action:

1. Make sure the baud rate your software and COM port required is the one your flow controller is using (MENU → SETUP → RS-232 Serial or RS-485 Serial → Baud Rate).
2. Check the flow controller unit ID (MENU → SETUP → RS-232 Serial or RS-485 Serial → Unit ID) to make sure you are addressing it properly with your serial commands.
3. Check the pinout (see from page 32 to page 34).
4. Make sure the COM number matches the one your software is using to connect to the flow controller.
5. On the external serial communications device (computer, PLC, etc.), be sure that the flow control (handshaking) settings are set as on page 23.

Still experiencing issues? Please contact support. See "Contact Information" on page 2.

Maintenance

Cleaning

Your flow controller does not require cleaning, provided that it has been flowing clean, dry gas. If necessary, the outside of the device can be cleaned with a soft dry cloth.



Caution: *If you suspect that debris or other foreign material has entered your device, do not take apart the flow body to clean it, as this will negate its NIST-traceable calibration. Please contact support for cleaning (page 2).*

Recalibration

The recommended period for recalibration is once every year. A label located on the back of the device lists the most recent calibration date. This date is also stored inside your flow controller and is visible by selecting MENU → ABOUT → About Device.

When it is time for your device's annual recalibration, contact support (page 2) with your device's serial number and your contact information.

Reference Information

Engineering Units

For more information on engineering units, see [page 20](#).

Pressure Units

Absolute or Barometric	Gauge	Notes
PaA	PaG	Pascal
hPaA	hPaG	Hectopascal
kPaA	kPaG	Kilopascal
MPaA	MPaG	Megapascal
mbarA	mbarG	Millibar
barA	barG	Bar
g/cm ² A	g/cm ² G	Gram force per square centimeter [†]
kg/cm ² A	kg/cm ² G	Kilogram force per square centimeter*
PSIA	PSIG	Pound force per square inch
PSFA	PSFG	Pound force per square foot
mTorrA	mTorrG	Millitorr
torrA	torrG	Torr
mmHgA	mmHgG	Millimeter of mercury at 0°C
inHgA	inHgG	Inch of mercury at 0°C
mmH ₂ O A	mmH ₂ O G	Millimeter of water at 4°C (NIST conventional) [†]
mmH ₂ O A	mmH ₂ O G	Millimeter of water at 60°C [†]
cmH ₂ O A	cmH ₂ O G	Centimeter of water at 4°C (NIST conventional) [†]
cmH ₂ O A	cmH ₂ O G	Centimeter of water at 60°C [†]
inH ₂ O A	inH ₂ O G	Inch of water at 4°C (NIST conventional) [†]
inH ₂ O A	inH ₂ O G	Inch of water at 60°C [†]
atm		Atmosphere
m asl		Meter above sea level
ft asl		Foot above sea level
V		Volt
count	count	Setpoint count, 0–64000
%	%	Percent of full scale

Temperature Units

Label	Notes
°C	Degrees Celsius
°F	Degrees Fahrenheit
K	Kelvin
°R	Degrees Rankine

* Displayed as kg/cmA and kg/cmG.

[†] Superscript and subscript numerals are displayed as lining (normal) numerals.

‡ Instances of μ are displayed as a lower-case u.

Flow Units

Volumetric	Standard	Normal	Notes
μ L/m	S μ L/m	N μ L/m	Microliter per minute [‡]
mL/s	SmL/s	NmL/s	Milliliter per second
mL/m	SmL/m	NmL/m	Milliliter per minute
mL/h	SmL/h	NmL/h	Milliliter per hour
L/s	SL/s	NL/s	Liter per second
LPM	SLPM	NLPM	Liter per minute
L/h	SL/h	NL/h	Liter per hour
US GPM			US gallon per minute
US GPH			US gallon per hour
CCS	SCCS	NCCS	Cubic centimeter per second
CCM	SCCM	NCCM	Cubic centimeter per minute
cm ³ /h	Scm ³ /h	Ncm ³ /h	Cubic centimeter per hour [†]
m ³ /m	Sm ³ /m	Nm ³ /m	Cubic meter per minute [†]
m ³ /h	Sm ³ /h	Nm ³ /h	Cubic meter per hour [†]
m ³ /d	Sm ³ /d	Nm ³ /d	Cubic meter per day [†]
in ³ /m	Sin ³ /m		Cubic inch per minute [†]
CFM	SCFM		Cubic foot per minute
CFH	SCFH		Cubic foot per hour
CFD	SCFD		Cubic foot per day
	kSCFM		1000 cubic feet per minute
count	count	count	Setpoint count, 0–64000
%	%	%	Percent of full scale

True Mass Flow Units

Label	Notes
mg/s	Milligram per second
mg/m	Milligram per minute
g/s	Gram per second
g/m	Gram per minute
g/h	Gram per hour
kg/m	Kilogram per minute
kg/h	Kilogram per hour
oz/s	Ounce per second
oz/m	Ounce per minute
lb/m	Pound per minute
lb/h	Pound per hour

Time Units

Label	Notes
h:m:s	Hours:Minutes:Seconds
ms	Milliseconds
s	Seconds
m	Minutes
hour	Hours
day	Days

Total Units

Label	Notes
μ L	MicroLiter [‡]
mL	MilliLiter
L	Liter
US GAL	US gallon
cm ³	Cubic centimeter [†]
m ³	Cubic meter [†]
in ³	Cubic inch [†]
ft ³	Cubic foot [†]
μ P	Micropoise, a measure of viscosity*
mg	Milligrams
g	Grams
kg	Kilograms
oz	US ounces
lb	US pounds

Gas List by Number

To use any of these gases in your device, use Gas Select™ (page 18).

#	Short Name	Long Name
0	Air	Air (Clean Dry)
1	Ar	Argon
2	CH4	Methane
3	CO	Carbon Monoxide
4	CO2	Carbon Dioxide
5	C2H6	Ethane
6	H2	Hydrogen
7	He	Helium
8	N2	Nitrogen
9	N2O	Nitrous Oxide
10	Ne	Neon
11	O2	Oxygen
12	C3H8	Propane
13	nC4H10	Normal Butane
14	C2H2	Acetylene
15	C2H4	Ethylene (Ethene)
16	iC4H10	Isobutane
17	Kr	Krypton
18	Xe	Xenon
19	SF6	Sulfur Hexafluoride ¹
20	C-25	25% CO ₂ , 75% Ar
21	C-10	10% CO ₂ , 90% Ar
22	C-8	8% CO ₂ , 92% Ar
23	C-2	2% CO ₂ , 98% Ar
24	C-75	75% CO ₂ , 25% Ar
25	He-25	25% He, 75% Ar
26	He-75	75% He, 25% Ar
27	A1025	90% He, 7.5% Ar, 2.5% CO ₂
28	Star29	Stargon CS (90% Ar, 8% CO ₂ , 2% O ₂)
29	P-5	5% CH ₄ , 95% Ar
30	NO	Nitric Oxide ²
31	NF3	Nitrogen Trifluoride ²
32	NH3	Ammonia ²
33	Cl2	Chlorine ²
34	H2S	Hydrogen Sulfide ²
35	SO2	Sulfur Dioxide ²
36	C3H6	Propylene ²
80	1Buten	1-Butylene ²
81	cButen	Cis-Butene (cis-2-Butene) ²
82	iButen	Isobutene ²
83	tButen	Trans-2-Butene ²
84	COS	Carbonyl Sulfide ²
85	DME	Dimethylether (C ₂ H ₆ O) ²
86	SiH4	Silane ²
100	R-11	Trichlorofluoromethane (CCl ₃ F) ^{2,3}

#	Short Name	Long Name
101	R-115	Chloropentafluoroethane (C ₂ ClF ₅) ^{2,3}
102	R-116	Hexafluoroethane (C ₂ F ₆) ²
103	R-124	Chlorotetrafluoroethane (C ₂ HClF ₄) ^{2,3}
104	R-125	Pentafluoroethane (CF ₃ CHF ₂) ^{2,3}
105	R-134A	Tetrafluoroethane (CH ₂ FCF ₃) ^{2,3}
106	R-14	Tetrafluoromethane (CF ₄) ²
107	R-142b	Chlorodifluoroethane (CH ₃ CClF ₂) ^{2,3}
108	R-143a	Trifluoroethane (C ₂ H ₃ F ₃) ^{2,3}
109	R-152a	Difluoroethane (C ₂ H ₄ F ₂) ²
110	R-22	Difluoromonochloromethane (CHClF ₂) ^{2,3}
111	R-23	Trifluoromethane (CHF ₃) ^{2,3}
112	R-32	Difluoromethane (CH ₂ F ₂) ^{2,3}
113	R-318	Octafluorocyclobutane (C ₄ F ₈) ²
114	R-404A	44% R-125, 4% R-134A, 52% R-143A ^{2,3}
115	R-407C	23% R-32, 25% R-125, 52% R-143A ^{2,3}
116	R-410A	50% R-32, 50% R-125 ^{2,3}
117	R-507A	50% R-125, 50% R-143A ^{2,3}
140	C-15	15% CO ₂ , 85% Ar
141	C-20	20% CO ₂ , 80% Ar
142	C-50	50% CO ₂ , 50% Ar
143	He-50	50% He, 50% Ar
144	He-90	90% He, 10% Ar
145	Bio5M	5% CH ₄ , 95% CO ₂
146	Bio10M	10% CH ₄ , 90% CO ₂
147	Bio15M	15% CH ₄ , 85% CO ₂
148	Bio20M	20% CH ₄ , 80% CO ₂
149	Bio25M	25% CH ₄ , 75% CO ₂
150	Bio30M	30% CH ₄ , 70% CO ₂
151	Bio35M	35% CH ₄ , 65% CO ₂
152	Bio40M	40% CH ₄ , 60% CO ₂
153	Bio45M	45% CH ₄ , 55% CO ₂
154	Bio50M	50% CH ₄ , 50% CO ₂
155	Bio55M	55% CH ₄ , 45% CO ₂
156	Bio60M	60% CH ₄ , 40% CO ₂
157	Bio65M	65% CH ₄ , 35% CO ₂
158	Bio70M	70% CH ₄ , 30% CO ₂
159	Bio75M	75% CH ₄ , 25% CO ₂
160	Bio80M	80% CH ₄ , 20% CO ₂
161	Bio85M	85% CH ₄ , 15% CO ₂
162	Bio90M	90% CH ₄ , 10% CO ₂
163	Bio95M	95% CH ₄ , 5% CO ₂
164	EAN-32	32% O ₂ , 68% N ₂
165	EAN-36	36% O ₂ , 64% N ₂
166	EAN-40	40% O ₂ , 60% N ₂
167	HeOx20	20% O ₂ , 80% He
168	HeOx21	21% O ₂ , 79% He
169	HeOx30	30% O ₂ , 70% He
170	HeOx40	40% O ₂ , 60% He
171	HeOx50	50% O ₂ , 50% He
172	HeOx60	60% O ₂ , 40% He

#	Short Name	Long Name
173	HeOx80	80% O ₂ , 20% He
174	HeOx99	99% O ₂ , 1% He
175	EA-40	Enriched Air-40% O ₂
176	EA-60	Enriched Air-60% O ₂
177	EA-80	Enriched Air-80% O ₂
178	Metab	Metabolic Exhalant (16% O ₂ , 78.04% N ₂ , 5% CO ₂ , 0.96% Ar)
179	LG-4.5	4.5% CO ₂ , 13.5% N ₂ , 82% He
180	LG-6	6% CO ₂ , 14% N ₂ , 80% He
181	LG-7	7% CO ₂ , 14% N ₂ , 79% He
182	LG-9	9% CO ₂ , 15% N ₂ , 76% He
183	HeNe-9	9% Ne, 91% He
184	LG-9.4	9.4% CO ₂ , 19.25% N ₂ , 71.35% He
185	SynG-1	40% H ₂ , 29% CO, 20% CO ₂ , 11% CH ₄
186	SynG-2	64% H ₂ , 28% CO, 1% CO ₂ , 7% CH ₄
187	SynG-3	70% H ₂ , 4% CO, 25% CO ₂ , 1% CH ₄
188	SynG-4	83% H ₂ , 14% CO, 3% CH ₄
189	NatG-1	93% CH ₄ , 3% C ₂ H ₆ , 1% C ₃ H ₈ , 2% N ₂ , 1% CO ₂
190	NatG-2	95% CH ₄ , 3% C ₂ H ₆ , 1% N ₂ , 1% CO ₂
191	NatG-3	95.2% CH ₄ , 2.5% C ₂ H ₆ , 0.2% C ₃ H ₈ , 0.1% C ₄ H ₁₀ , 1.3% N ₂ , 0.7% CO ₂
192	CoalG	50% H ₂ , 35% CH ₄ , 10% CO, 5% C ₂ H ₄
193	Endo	75% H ₂ , 25% N ₂
194	HHO	66.67% H ₂ , 33.33% O ₂
195	HD-5	LPG: 96.1% C ₃ H ₈ , 1.5% C ₂ H ₆ , 0.4% C ₃ H ₆ , 1.9% n-C ₄ H ₁₀
196	HD-10	LPG: 85% C ₃ H ₈ , 10% C ₃ H ₆ , 5% n-C ₄ H ₁₀
197	OCG-89	89% O ₂ , 7% N ₂ , 4% Ar
198	OCG-93	93% O ₂ , 3% N ₂ , 4% Ar
199	OCG-95	95% O ₂ , 1% N ₂ , 4% Ar
200	FG-1	2.5% O ₂ , 10.8% CO ₂ , 85.7% N ₂ , 1% Ar
201	FG-2	2.9% O ₂ , 14% CO ₂ , 82.1% N ₂ , 1% Ar
202	FG-3	3.7% O ₂ , 15% CO ₂ , 80.3% N ₂ , 1% Ar
203	FG-4	7% O ₂ , 12% CO ₂ , 80% N ₂ , 1% Ar
204	FG-5	10% O ₂ , 9.5% CO ₂ , 79.5% N ₂ , 1% Ar
205	FG-6	13% O ₂ , 7% CO ₂ , 79% N ₂ , 1% Ar
206	P-10	10% CH ₄ 90% Ar
210	D-2	Deuterium

¹ Sulfur hexafluoride is a highly potent greenhouse gas monitored under the Kyoto Protocol.

² Corrosive-resistant units only

³ Under the Montreal Protocol and Kigali Amendment, the production and consumption of these ozone-depleting substances (ODS) is being or has been phased out. It is recommended you ensure compliance with this universally ratified treaty before attempting to use these gases, in addition to R113, R-123, and R-141b.

Gas List by Category

See previous page for Gas Select™ index numbers, or [page 18](#) to configure these gases.

Pure Non-Corrosive Gases

Acetylene (C₂H₂)
Air (clean, dry)
Argon (Ar)
Isobutane (i-C₄H₁₀)
Normal Butane (n-C₄H₁₀)
Carbon dioxide (CO₂)
Carbon monoxide (CO)
Deuterium (D₂)
Ethane (C₂H₆)
Ethylene (Ethene) (C₂H₄)
Helium (He)
Hydrogen (H₂)
Krypton (Kr)
Methane (CH₄)
Neon (Ne)
Nitrogen (N₂)
Nitrous Oxide (N₂O)
Oxygen (O₂)
Propane (C₃H₈)
Sulfur Hexafluoride (SF₆)¹
Xenon (Xe)

Breathing Gases

Metabolic Exhalant
EAN-32
EAN-36
EAN-40
EA-40
EA-60
EA-80
Heliox-20
Heliox-21
Heliox-30
Heliox-40
Heliox-50
Heliox-60
Heliox-80
Heliox-99

Bioreactor Gas Mixes

5%–95% CH₄/CO₂ in 5% increments

Refrigerants²

R-11³
R-14
R-22³
R-23³
R-32³
R-115³
R-116
R-124³
R-125³
R-134a³
R-142b³
R-143a³
R-152a
R-318
R-404A³
R-407C³
R-410A³
R-507A³

Welding Gases

C-2
C-8
C-10
C-15
C-20
C-25
C-50
C-75
He-25
He-50
He-75
He-90
A 1025
Stargon CS

Chromatography Gas Mixes

P-5
P-10

Oxygen Concentrator Gas Mixes

89% O₂, 7.0% N₂, 4.0% Ar
93% O₂, 3.0% N₂, 4.0% Ar
95% O₂, 1.0% N₂, 4.0% Ar

Stack/Flue Gas Mixes

2.5% O₂, 10.8% CO₂, 85.7% N₂, 1.0% Ar
2.9% O₂, 14% CO₂, 82.1% N₂, 1.0% Ar
3.7% O₂, 15% CO₂, 80.3% N₂, 1.0% Ar
7.0% O₂, 12% CO₂, 80% N₂, 1.0% Ar
10% O₂, 9.5% CO₂, 79.5% N₂, 1.0% Ar
13% O₂, 7.0% CO₂, 79% N₂, 1.0% Ar

Laser Gas Mixes

4.5% CO₂, 13.5% N₂, 82% He
6.0% CO₂, 14% N₂, 80% He
7.0% CO₂, 14% N₂, 79% He
9.0% CO₂, 15% N₂, 76% He
9.4% CO₂, 19.25% N₂, 71.35% He
9.0% Ne, 91% He

Fuel Gas Mixes

Coal Gas 50% H₂, 35% CH₄, 10% CO, 5% C₂H₄
Endothermic Gas 75% H₂, 25% N₂
HHO 66.67% H₂, 33.33% O₂
LPG HD-5 96.1% C₃H₈, 1.5% C₂H₆, 0.4% C₃H₆, 1.9% n-C₄H₁₀
LPG HD-10 85% C₃H₈, 10% C₃H₆, 5% n-C₄H₁₀

Natural Gases

93.0% CH₄, 3.0% C₂H₆, 1.0% C₃H₈, 2.0% N₂, 1.0% CO₂
95.0% CH₄, 3.0% C₂H₆, 1.0% N₂, 1.0% CO₂
95.2% CH₄, 2.5% C₂H₆, 0.2% C₃H₈, 0.1% C₄H₁₀, 1.3% N₂, 0.7% CO₂

Synthesis Gases

40% H₂, 29% CO, 20% CO₂, 11% CH₄
64% H₂, 28% CO, 1.0% CO₂, 7.0% CH₄
70% H₂, 4.0% CO, 25% CO₂, 1.0% CH₄
83% H₂, 14% CO, 3.0% CH₄

Pure Corrosive Gases²

Ammonia (NH₃)
Butylene (1-Buten)
Cis-Butene (c-Buten)
Isobutene (i-Buten)
Trans-Butene (t-Buten)
Carbonyl Sulfide (COS)
Chlorine (Cl₂)
Dimethylether (DME)
Hydrogen Sulfide (H₂S)
Nitrogen Trifluoride (NF₃)
Nitric Oxide (NO)
Propylene (C₃H₆)
Silane (SiH₄)
Sulfur Dioxide (SO₂)

¹ Sulfur hexafluoride is a highly potent greenhouse gas monitored under the Kyoto Protocol.

² Corrosive-resistant units only

³ Under the Montreal Protocol and Kigali Amendment, the production and consumption of these ozone-depleting substances (ODS) is being or has been phased out. It is recommended you ensure compliance with this universally ratified treaty before attempting to use these gases, in addition to R113, R-123, and R-141b.

Pinouts

Check the calibration data sheet and pinout for your device.

See [page 23](#) for additional important information about connecting your device to a computer for serial commands. Individual pinouts available at alicat.com/pinout.

8-Pin Mini-DIN (Default)

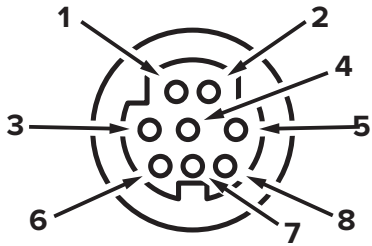

Female Connector: Device

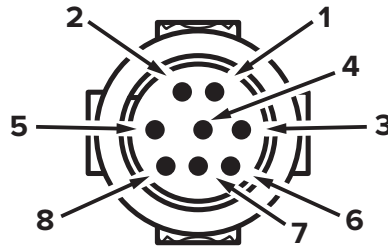

Male Connector: Cable

Pin	Function
1	Not Connected <i>Optional: 4–20 mA primary output signal</i>
2	Static 5.12 Vdc <i>Optional: secondary analog output (4–20 mA, 0–5 Vdc, 1–5 Vdc, 0–10 Vdc) or basic alarm</i>
3	Serial RS-232RX Input Signal <i>Optional: RS-485 A</i>
4	Analog Setpoint Input
5	Serial RS-232TX Output Signal <i>Optional: RS-485 B</i>
6	0–5 Vdc Analog Out <i>Optional: 1–5 Vdc or 0–10 Vdc output signal</i>
7	Power In
8	Ground (common for power, digital communications, analog signals, and alarms)



Warning: Do not connect power to pins 1 through 6, as permanent damage can occur. It is common to mistake pin 2 (labeled 5.12 Vdc Output) as the standard 0–5 Vdc analog output signal. Pin 2 is normally a constant 5.12 Vdc.

Locking Industrial Connector Pinout

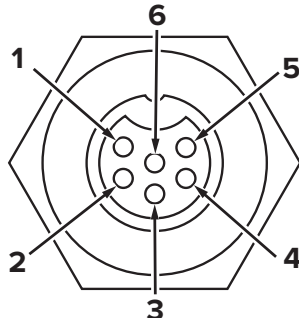
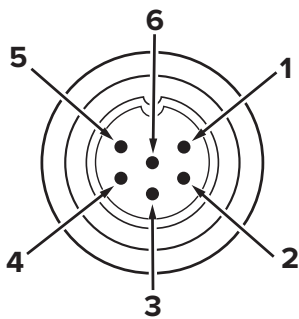

Pin	Function
1	Power In (+)
2	RS-232TX / RS-485 B
3	RS-232RX / RS-485 A
4	Analog Setpoint Input
5	Ground (common for power, communications, and signals)
6	Analog Out (voltage or current as ordered)



Note: The availability of different output signals depend on the options ordered.

9-Pin D-Sub Connector Common Pinouts

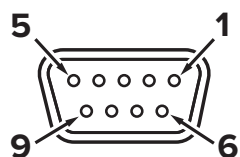

Female Connector

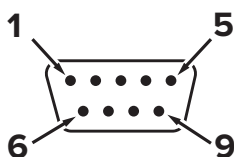

Male Connector

Pin	DB9 (F) DB9M (M)	DB9A and DB9K	DB9R	DB9T	DB9U	DB9B	DB9G	DB9H	DB9I	DB9N
1	Current Out	NC	TX or B	TX or B	RX or A	Analog Out 2	RX or A	TX or B	NC	Power In
2	Analog Out 2	Analog Out	Analog Out	Analog Out	Analog Out	Analog Out	Analog Out	Analog Out	Analog Out	Analog In
3	RX or A	Power In	Analog In	Power In	Power In	Power In	Ground	Analog In	Power In	Analog Out
4	Analog In	Ground	Ground	Ground	Ground	Ground	Power In	RX or A	Ground	NC
5	TX or B	TX or B	NC	NC	NC	Ground	Ground	Analog Out 2	NC	Ground
6	Analog Out	Analog In	RX or A	Analog In	Analog In	Analog In	TX or B	NC	Analog In	Ground
7	Power In	Ground	Power In	Ground	Ground	Ground	Analog In	Power In	Ground	RX or A
8	Ground	Ground	Ground	Ground	Ground	TX or B	Current Out	Ground	RX or A	TX or B
9	Ground	RX or A	Ground	RX or A	TX or B	RX or A	Ground	Ground	TX or B	NC5

15-Pin D-Sub Connector Common Pinouts

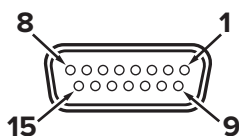

Female Connector: Cable

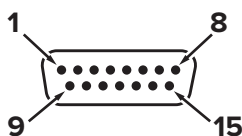

Male Connector: Device

Pin	DB15	DB15A	DB15B	DB15H	DB15K	DB15O	DB15S
1	Ground	Ground	Ground	NC	NC	Ground	Ground
2	Analog Out	Analog Out	Analog Out	RX or A	Analog Out	NC	Analog Out
3	Ground	Analog In	NC	NC	NC	NC	NC
4	NC	Ground	NC	NC	NC	Analog Out	NC
5	Power In	Ground	Power In	Ground	Ground	Power In	Ground
6	NC	Ground	NC	Analog Out	NC	NC	NC
7	NC	Power In	NC	Ground	Power In	Analog In	NC
8	Analog In	TX or B	Analog In	NC	Analog In	NC5	Analog In
9	Ground	Ground	Ground	NC	Analog Out 2	Ground	Ground
10	Ground	NC	Ground	Analog Out 2	NC	Ground	Ground
11	Analog Out 2	NC	Analog Out 2	Power In	Ground	Analog Out 2	Analog Out 2
12	NC	Analog Out 2	NC	Ground	Ground	NC	RX or A
13	RX or A	NC	NC	NC	RX or A	NC	Power In
14	Ground	NC	RX or A	Analog In	TX or B	RX or A	TX or B
15	TX or B	RX or A	TX or B	TX or B	Ground	TX or B	Ground

Key of Terms:

Analog In

Analog Setpoint Input

Analog Out

0–5 Vdc output signal (1–5, 0–10 Vdc optional)

Analog Out 2

5.12 Vdc or optional secondary analog output

Current Out

Not connected

NC Not connected

Power In (+Vdc)

RX or A

Serial RS-232RX or RS-485 A

TX or B

Serial RS-232TX or RS-485 B

Ground

Common for power, digital communications, analog signals, alarms

M12 Connector Common Pinouts

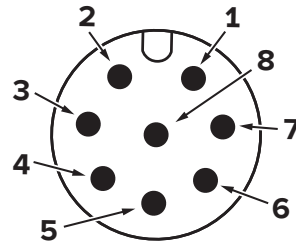
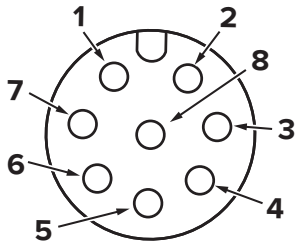

Female Connector: Cable

Male Connector: Device

Pin	M12	M12MD
1	0–5 Vdc Output Signal <i>Optional: 1–5 or 0–10 Vdc</i>	Not Connected <i>Optional: 4–20 mA primary output signal</i>
2	Power In	Static 5.12 Vdc <i>Optional: Secondary analog output (4–20 mA, 0–5 Vdc, 1–5 Vdc, 0–10 Vdc) or basic alarm</i>
3	Serial RS-232 RX signal <i>Optional: RS-485 A</i>	Serial RS-232 RX Signal <i>Optional: RS-485 A</i>
4	Analog Setpoint Input	Analog Setpoint Input
5	Serial RS-232 TX signal <i>Optional: RS-485 B</i>	Serial RS-232 TX Signal <i>Optional: RS-485 B</i>
6	Static 5.12 Vdc <i>Optional: Secondary analog output (4–20 mA, 0–5 Vdc, 1–5 Vdc, 0–10 Vdc) or basic alarm</i>	0–5 Vdc Output Signal <i>Optional: 1–5 or 0–10 Vdc</i>
7	Ground (common for power, digital communications, analog signals, and alarms)	Power in
8	Inactive <i>Optional: 4–20 mA primary output signal</i>	Ground (common for power, digital communications, analog signals, and alarms)



Main Display page 10

PSIA +13.49	°C +26.03	SETPT +0.0000
+0.0000 SLPM Air		
Mass Flow		
+0.0000 LPM	+0.0000 SLPM	MENU
LPM	SLPM	NEXT

Main Menu page 10

CONTROL	ABOUT	TARE
		FLOW
BACK	SETUP	MAIN

ABOUT

About Menu page 17

	UP	DOWN
>About Device	>	>
Full Scale Ranges	>	>
About Manufacturer	>	>
BACK	MAIN	SELECT

Totalizer page 11

TOTAL/ TIMER	SETPT +0.0000	SLPM +0.0000
	Air	
+0.0000		
0:00 h:m:s		
-NONE-	BATCH	RESET
		MENU

Setup page 18

	UP	DOWN
>Active Gas: Air	>	>
Sensor	>	>
RS-232 Serial	>	>
Display	>	>
Advanced	>	>
BACK	MAIN	SELECT

Gas Select™ page 18

	PAGE	UP	DOWN
>Recent	>	>	>
Standard	>	>	>
COMPOSER Mixes	>	>	>
Bioreactor	>	>	>
Breathings	>	>	>
Chromatography	>	>	>
Fuel	>	>	>
BACK	MAIN	SELECT	

Setpoint page 13

SELECT	UP	DOWN
DIGIT		
Setpoint		
+0.0000		
^		
SLPM: +1.000 Max		
CANCEL	CLEAR	SET

Control page 13

	UP	DOWN
>Setpt: +0.0000 SLPM	>	>
Setpoint Setup	>	>
Control Loop	>	>
Setpoint Ramp	>	>
Show Valve: None	>	>
BACK	MAIN	SELECT

Sensor Setup page 20

	UP	DOWN
>Engineers Units	>	>
STP Flow Reference	>	>
Flow Averaging	>	>
Pressure Averaging	>	>
Zero Band	>	>
BACK	MAIN	SELECT

Setpoint Setup page 13

	UP	DOWN
>Zero Setpoint	>	>
Setpoint Source	>	>
On Modbus Timeout	>	>
Power Up Setpoint	>	>
Setpoint Limits	>	>
BACK	MAIN	SELECT

Setpt

Setpoint Setup

Serial Comm. page 21

	UP	DOWN
>Unit ID: A	>	>
Modbus Address: 1	>	>
Modbus: Always Wait	>	>
Baud Rate: 19200	>	>
BACK	MAIN	SELECT

Control Loop page 14

	UP	DOWN
>Control: Mass Flow	>	>
Loop Type: PD2I	>	>
P Gain: 167	>	>
I Gain: 1280	>	>
D Gain: 10	>	>
Flow Limiter	>	>
Control Deadband	>	>
BACK	MAIN	SELECT

Control Loop

Display Setup page 21

	UP	DOWN
>MAIN Screen	>	>
Screen Lightings	>	>
Display Rotation	>	>
BACK	MAIN	SELECT

Display

Setpoint Ramping page 16

	UP	DOWN
>Ramp: 100.0000	>	>
Units: SLPM / s	>	>
Set by Delta / Time	>	>
Ramp Up: On	>	>
Ramp Down: Off	>	>
Power Up: Allow Ramp	>	>
0 Setpt: No Ramp	>	>
BACK	MAIN	SELECT

Setpoint Ramp

Advanced Setup page 22

	UP	DOWN
>Factory Restore	>	>
Resister Status	>	>
Edit Resister	>	>
Device Properties	>	>
BACK	MAIN	SELECT

Advanced

